



**Department of Civil Engineering**

**Regulation 2021**

**II Year – IV Semester**

**GE3451 Environmental Sciences and Sustainability**

**UNIT – I****ENVIRONMENT, ECOSYSTEMS AND BIO-DIVERSITY****1.1 Introduction**

❖ The word environment is derived from the French word “**Environ**” meaning “**Surroundings**”. **Each and everything around us** is called as Environment.

❖ **Environment:**

It is the sum of all the living and non- living things around us influencing one another

❖ **Environmental Science:**

It is the study of the Environment, its biotic and abiotic components and their interrelationship.

❖ **Environmental Engineering:**

It is the application of engineering principles to the protection and enhancement of the quality of the environment and to the enhancement and protection of public health and welfare.

❖ **Environmental studies:**

It is the process of educating the people for preserving quality environment.

**1.2 Scope of Environmental studies:**

- To get an awareness and sensitivity of the environment and its related problems.
- To motivate the active participation in environmental protection and improvement.

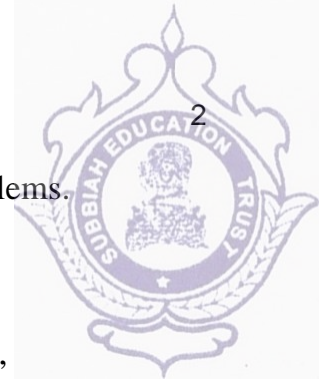

## Environment and Sustainability

- To develop skills for identifying and solving Environmental problems.
- To know the necessity of conservation of natural resources.
- To evaluate the environmental problems in terms of social, economic, ecological and aesthetic factors.

### 1.3 Importance / Significance of Environmental studies:

The knowledge of environmental studies is very important, because there is no zero pollution industries. All are contaminated by the industrial activities and the valuable resources are polluted.

- By the environmental studies, people will understand the need of development without destruction of environment
- Through the studies, people can gain the knowledge and different environmental hazards.
- Through the studies, people know about their role in protecting the environment through the laws and enforcement systems.
- Environmental studies have a direct relation to the quality of life we live.

### 1.4 Need for public awareness Community participation

The community participation plays a major role in the effective environmental management.

- **Pressure group**

These groups influence the government and industries.

- **Watch dog**

The public act as watch dog to protect the environment against the hazardous activities.

- **Advisory council**



Environment and Sustainability

The public act as advisory council to keep the environment suitable for living.

## 1.5 Ecosystem

**A group of organisms interacting among themselves and with environment is known as ecosystem.**

**Ecology: It is the study of interactions among organisms or a group of organism with their environment. The environment consists of both biotic and abiotic components**

(eg) animals cannot synthesise their food directly but depend on the plants directly or indirectly.

### **Biome (small ecosystem):**

Biomes are very large ecological areas on the earth surface, with flora and fauna adapting to their environment.

## 1.6 Structure (or) components of an ecosystem:

The structure of an ecosystem explains the relationship between the abiotic and biotic components.

1. Abiotic (or) Non-living components
2. Biotic (or) Living components

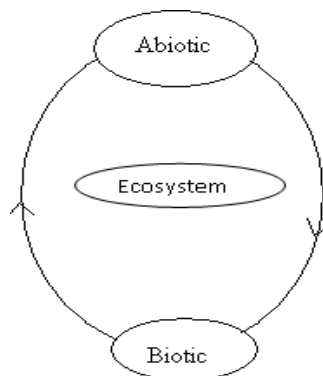

**Fig 1. 1 Components of an ecosystem**

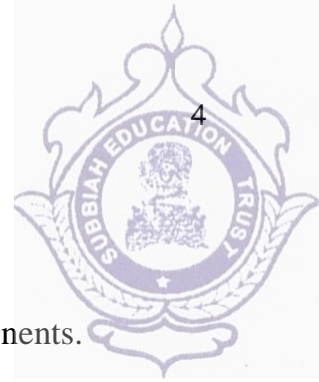

## 1. Abiotic (or) Non-living components

**The non – living components of the environment** are called abiotic components.

(i) Physical components	(ii) Chemical components
They are useful for the growth and maintenance of the components.	They are the sources of the essential nutrients.
It includes energy, climate and living space.	It includes organic and inorganic substances
(eg) air, soil, water etc.	(eg) organic substances - proteins, lipids etc. Inorganic substances - P, H, C etc.

## 2. Biotic (or) Living components

**The living organisms in an ecosystem form their community** is called biotic components.

### Classification of biotic components

#### 1. Producers (Autotrophs)

- They synthesize their food by themselves through photosynthesis.(eg) green plants,trees.
- The green pigment called chlorophyll converts CO<sub>2</sub> and H<sub>2</sub>O in the presence of sun light into carbohydrates.
- This process is called photosynthesis.

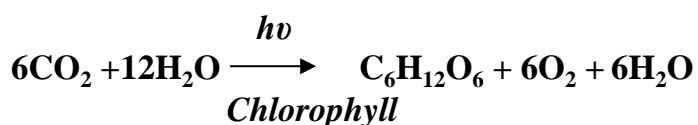

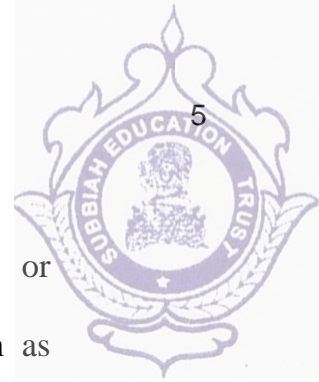

Environment and Sustainability

**2. Consumers (Heterotrophs)**

They cannot prepare their own food and depend directly or indirectly on the producers. (eg) (i) Plant eating species such as insects, rabbits, goat etc.

(ii) Animal eating species such as fish, lion, tiger etc.

**Types of consumers**

<b>Primary consumers (Herbivores)</b>	<b>Secondary Consumers (Primary carnivores)</b>	<b>Tertiary Consumers (secondary carnivores)</b>
They depend directly on plants for their food.	They feed on primary consumers.	They directly depend on secondary consumers for their food.
(eg) rabbit, goat, rat etc.	(eg) frog, cat, snakes etc.	(eg) tiger, lion etc.

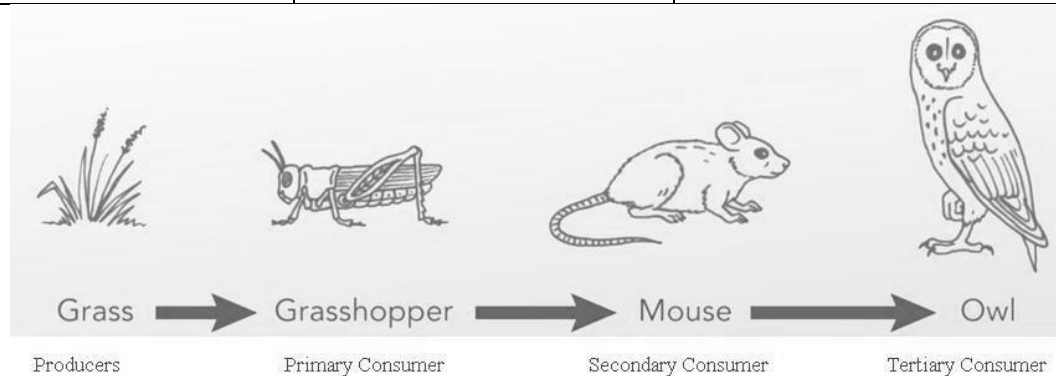

**Fig 1. 2 Biotic components of an ecosystem**

**3. Decomposers**

- They feed the dead organisms of plants, animals and then decompose into simpler compounds.
- During the decomposition, inorganic nutrients are released.
- (eg) bacteria and fungi.



## Environment and Sustainability

## 1.7 Energy flow in an ecosystem

- Energy is required for all living organism for their survival.
- The main source of energy in the ecosystem is sunlight.
- The flow of energy from producer level to top consumer level is called energy flow.
- About 80% of energy is lost during flow of energy from one trophic level to the next one.
- Energy flow in the ecosystem follows two laws of thermodynamics.
  - (i) **“Energy can neither be created nor destroyed; it can transfer from one form to another”**



(ie) Solar energy is converted into chemical energy.

- (ii) **“Whenever energy is transformed from one form to another, there is some loss of energy”**

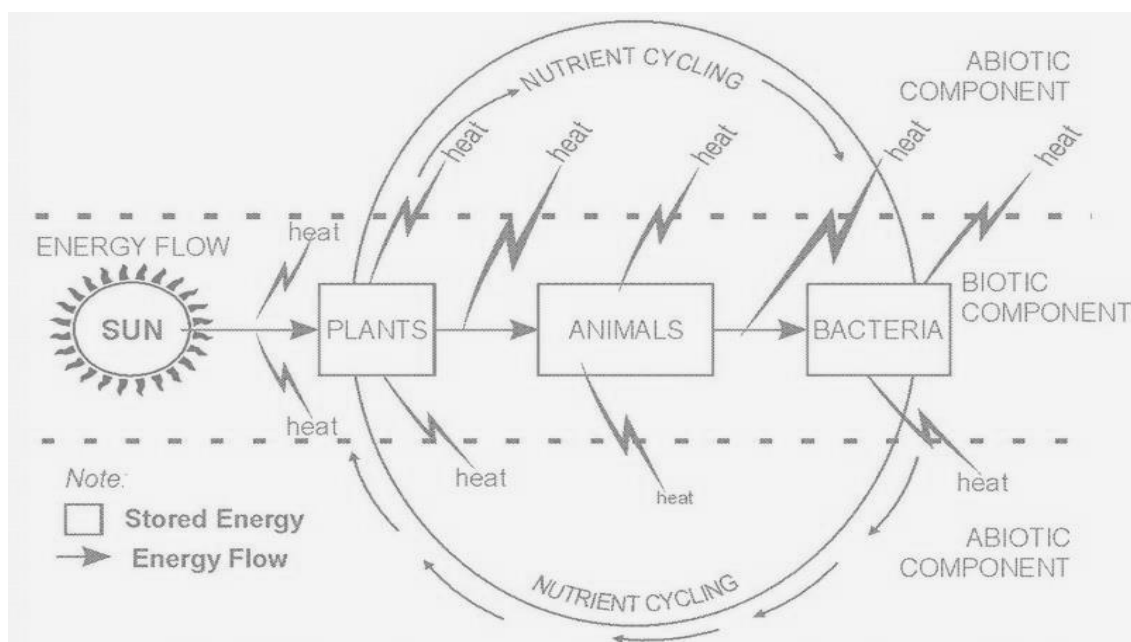
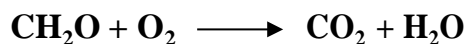

**Fig 1. 3 Energy flow in an ecosystem**



Environment and Sustainability

- During transformation, the loss of energy is due to respiration, hunting, running etc.



## 1.8 Ecological Succession

Ecological succession is defined as, “**Progressive replacement of one community by another till the development of stable community in a particular area**”.

### Stages of ecological succession

1. Pioneer community	2. Seres (or) seral stage
The first group of organism which establish their community in the area is called pioneer community	The various developmental stages of the community is called seres.

### Types of ecological succession:

#### 1. Primary Succession

It involves the gradual establishment of biotic communities on a lifeless ground.

a) Hydrarch (or) Hydrosere	b) Xerarch (or) Xerosere
Establishment starts in a watery area such as pond, lake.	Establishment starts in a dry area such as desert, rock.

#### 2. Secondary Succession

It involves the gradual establishment of biotic communities in an area where another biotic community is already present.

##### (i) Nudation

It is the development of bare area without any life form.



Environment and Sustainability

**(ii) Invasion**

It is the development of one or more species on a bare area through migration followed by establishment.

<b>a. Migration</b>	<b>b. Establishment</b>
The seeds are brought by wind, water, birds.	The seeds then germinate, grow and establish its community.

**(iii) Competition**

As the number of individual species grows, there is a competition between the same species or the different species for water, space, nutrients.

**(iv) Reaction**

The living organisms take water; nutrients then grow and modify the environment known as reaction. This modification is unsuitable for some existing species and favours for some new species, which replace the existing species.

**(v) Stabilizations.**

It leads to the formation of stable community.

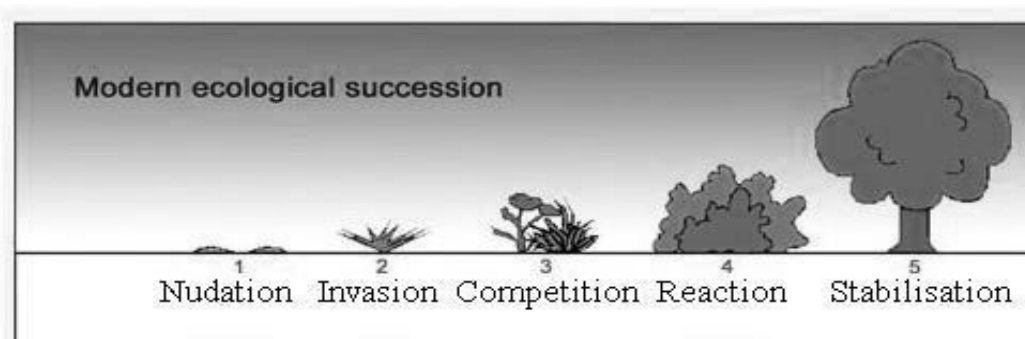

**Fig 1.4 Stages of ecological succession**

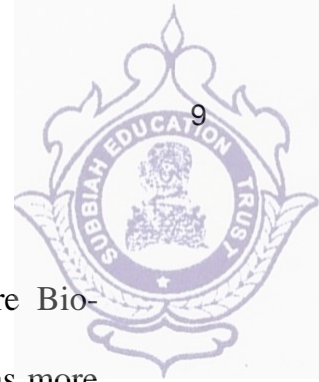

## 1.9 Bio-Diversity

‘Bio’ means **‘life’** and ‘Diversity’ means **‘variety’**. Therefore Bio-Diversity means wide variety of life on earth. Our planet earth contains more than 20 million species of organisms. Out of which only 1.4 million species have been identified.

Bio-Diversity is defined as” **the variety and variability among all groups of living organisms and the ecosystem in which they occur.”**

### 1.10 Classification of Bio-Diversity

1. Genetic diversity	2. Species diversity	3. community diversity
The diversity within the species is called genetic diversity.	Diversity between different species is called species diversity.	The diversity at the ecological (or) habitat level is known as ecosystem diversity.
(eg) rice varieties.	(eg) <b>Plant species</b> – apple, mango, grapes, wheat etc. <b>Animal species</b> – cow, deer, dog etc.	(eg) <b>River ecosystem-</b> It includes fishes, aquatic insects, mussels and variety of plants.

### 1.11 Significance of biodiversity

1. Biodiversity is important for human life, as we depend on plants, animals, microorganisms for our food, medicine and industrial products.
2. It is important for forestry, fisheries and agriculture.
3. Biodiversity protects the fresh air, clean water and productive land.



Environment and Sustainability

## 1.12 Value (or) use of bio-diversity

### 1. Consumptive use value

- These are direct use values, where the biodiversity products are harvested and consumed directly.
- (eg) Food, drug, fuel

<b>Food</b>	A large number of wild plants and wild animals are consumed by human beings as food.  (eg) Molluscs, spider etc.		
<b>Drugs</b>	Around 70% of modern medicines are derived from plants and plant extracts. In India, 3,000 plant species are used in Ayurveda, Unani and Siddha.		
	Penicillin	Fungus	Antibiotic
	Streptomycin	Actinomycete	Antibiotic
	Quinine	Cinchona bark	Malaria
	Reserpine	Rauwolfia	Hypertension
	Morphine	Poppy	Painkiller
<b>Fuel</b>	Fire woods are directly consumed by villagers and tribals. (eg) Coal, petroleum, natural gases are fossilized		

### 2. Productive use

- Biodiversity products are having commercial value.
- These products are derived from animals and plants and they are marketed and sold.

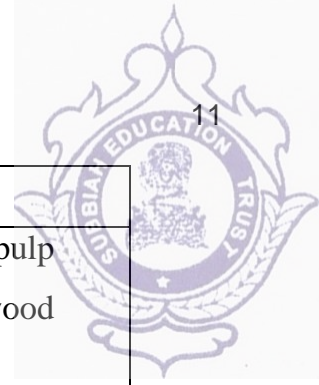

## Environment and Sustainability

Animal products	Animal	Plant product	Industry
Silk	Silk worm	Wood	Paper and pulp industry, plywood industry
Wool	Sheep	cotton	Textile industry
Musk	Musk deer	Fruits, vegetables	Food industry
Tusk	Elephant	Oil seed	Oil industry
Leather	All animals	Rice	Flour industry

### 3. Social value

- It refers the bio resources are used in the society.
- These are associated with the social life, religion, spiritual aspects of the people.
- (eg) Holy plants- Tulsi, lotus, bael, neem tree.

Holy animals – Cow, snake, peacock, rat

### 4. Ethical value

- It means that, any species may or may not be used, but its existence in nature gives as pleasure.
- (eg) River Ganga is a holy river. Vembu, Vengai, Tulsi are considered as holy trees.

### 5. Aesthetic value

- The beautiful nature of plants and animals insists us to protect the biodiversity.
- (eg) Colour of butterfly, colour of flowers

### 6. Optional value

- It suggests that any species may be proved it to be a valuable



Environment and Sustainability

species after some day. (eg) Growing bio-technology field is searching a species for curing cancer and AIDS.

### 1.13 India as a Mega Diversity Nation

India is one of the 12 mega diversity countries in the world. It has 89,450 animalspecies and 47,000 plant species.

Plants	Number	Animals	Number
Fungi	23,000	Mollusca	5,042
Bacteria	850	Lower groups	9,979
Algae	2,500	Arthropoda	57,525
Bryophytes	2,564	Amphibia	2,546
Gymnosperms	64	Birds	1,228
Pteridophytes	1,022	Reptiles	428
Angiosperms	15,000	Mammals	372

### 1.14 Hot spots of Bio- Diversity

The hot spots are **the geographic areas which has high endemic species.**

#### Criteria for recognizing hot spots:

1. The richness of the endemic species is the primary criterion for recognizing hot spots.
2. The hot spots should have a significant percentage of specialized species.
3. It should contain important gene pools of plants of potentially useful plants.

#### Reason for rich biodiversity in the tropics:

1. The tropics have a more stable climate.
2. Warm temperature and high humidity in the tropical areas provide favorable conditions
3. No single species can dominate and thus there is an opportunity

Environment and Sustainability  
for many species to coexist.

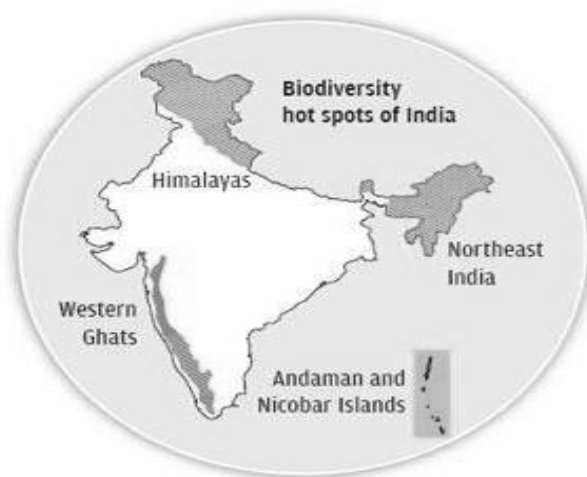

**Fig 1.5 Hot spots of Bio- Diversity**

The major hot spots of India are,

<b>(i) Eastern Himalayas:</b>	<b>(ii) Western Ghats:</b>
This comprises Nepal, Bhutan and neighbouring states of Northern India. There are 35,000 plant species found in Himalayas.	The area comprises Maharashtra, Karnataka, Tamil Nadu and Kerala.
(Eg) Rice, Banana, Citrus, Ginger, Chilli, Jute and Sugarcane.	Nearly 1500 dicotyledones, 62% amphibians and 50% lizards are endemic in Western Ghats.

**1.15 Threats to biodiversity**

**Any disturbance in natural ecosystem tends to reduce biodiversity.**

The causes for loss of biodiversity is given as,

**1. Habitat loss**

The loss of populations of inter breeding organisms is caused by habitat loss.

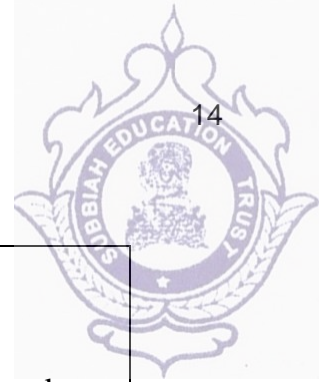

Environment and Sustainability  
**Factors:**

<p><b>a. Deforestation</b></p>	<ul style="list-style-type: none"> <li>• The loss of habitat is mainly caused by deforestation activities.</li> <li>• The forest and grass lands are converted to agricultural lands, settlement areas, developmental areas etc.</li> <li>• This affects the natural habitat of wild life.</li> </ul>
<p><b>b. Destruction of wet lands</b></p>	<ul style="list-style-type: none"> <li>• The wet lands, estuaries etc are destroyed by draining, filling and pollution, which causes a large biodiversity loss.</li> </ul>
<p><b>c. Habitat fragmentation</b></p>	<ul style="list-style-type: none"> <li>• Sometimes the habitat is divided into small and scattered patches. This is known as habitat fragmentation.</li> <li>• Due to this, many species are vanishing.</li> </ul>
<p><b>d. Production of drugs</b></p>	<ul style="list-style-type: none"> <li>• Many pharmaceutical companies collect wild plant for the production of drugs.</li> <li>• Therefore, many medicinal plants are on the verge of extinction.</li> </ul>
<p><b>e. Raw materials</b></p>	<ul style="list-style-type: none"> <li>• For a production of a single hybrid plant, we need more than two pounds of wild plants.</li> </ul>
<p><b>f. Illegal trade</b></p>	<ul style="list-style-type: none"> <li>• It also reduces the biodiversity.</li> </ul>
<p><b>g. Developmental activities</b></p>	<ul style="list-style-type: none"> <li>• The construction of massive dams in the forest areas, discharge of effluents kills the birds and other aquatic organisms.</li> </ul>

**2. Poaching**

It means **killing of animals (or) Commercial hunting.**

Subsistence poaching	Commercial poaching
Killing animals for food.	Hunting and killing animals to sell their products.



## Environment and Sustainability Factors

### a. Human population

Increased human population has led to pressure on forest resources.

### b. Commercial activities

Though, there is an international ban on trading the products of endangered species, smuggling of wild life products continues.

(e.g.) **Blue Morpho Butterfly** – To make attractive trays in Brazil.

**Snowy large egret** – Its white plumes are kept in ladies hats.

**Elephant feet** – To make ash trays, **Baleen** – To prepare combs.

### Remedies:

- Illegal hunting should be stopped immediately.
- Should not purchase the wild life products like fur coat, purse etc.
- Bio-diversity laws should be strengthened.

### 3. Man – wildlife conflicts

- When wildlife causes damage and danger to man, Man –wild life conflicts arise.
- (Eg) In Orisa, Sambalpur, 195 humans were killed by elephants in last 5 years, in retaliation, the villagers killed 98 elephants.
- Recently, 2 men were killed by leopards in Mumbai.
- In Kathmandu, 16 Nepalese, one 4-year child was killed by a man eating



Environment and Sustainability  
tiger.

- In Mysore, several elephants were killed by due to their damage of cotton and sugar canecrops.

### Factors

- Shrinkage of forest.
- Human encroachment into the forest area.
- Injured animals have a tendency to attack man.

### Remedies:

- Adequate crop and cattle compensation schemes must be started.

Cropping pattern should be changed near the forest.

### 1.16 Endangered and endemic species:

#### Endangered species of India:

A species is said to be **endangered**, when its number has been reduced to a **critical level**. **Number of threatened species of India:**

Group of species	Number of species
Plants	250
Birds	70
Mammals	86
molluscs	2
Reptiles	25
Amphibians	3
Fishes	3
Insects	50

The names of few species is given below,

- **Reptiles** – tortoise, green sea turtle, python
- **Birds** – peacock, Siberian white crane, pelican, and Indian bustard



Environment and Sustainability

- **Mammals** – Indian wolf, sloth bear, golden cat, desert cat.

### **Red - data book:**

- It is the book that contains the list of endangered species of plants and animals.
- It gives the warning signal for those species which are endangered and if not protected they become extinct in near future.

### **Factors affecting endangered species:**

#### **1. Pollution:**

- Humans dispose their waste products on land, river and air.
- These pollutants enter our environment and travel through the food chain and accumulate in the tissues of the living things leads to death.

#### **2. Over - Exploitation:**

- Over – exploitation of natural resources and poaching of wild animals leads to extinct of wild animals.

#### **3. Climate change:**

- Climate change threatens the organisms and ecosystems.

### **Remedies:**

“convention of International Trade in Endangered Species 1975”(CITES) treaty lists 900 species that cannot be commercially traded as live specimens or wild life products.

#### **1.17 Endemic species**

**The species which are found only in a particular region** are known as endemic species.

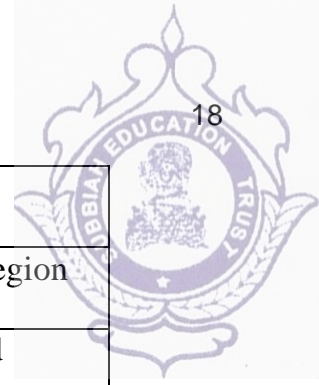

## Environment and Sustainability

1. Flora	2. Fauna
Plants present in a particular region	Animals present in a particular region
(eg) Sapria Himalayana, Nepenthes khasiana	(eg) Monitor lizards, reticulated python, Indian salamander etc.

**Endemic species in India**

Group of Animal /plant	Number of species
Plant	878
Insects	16214
Reptile	214
Amphibians	110
Pteridophyta	200
Angiosperms	4950

**Factors affecting endemic species**

1. Habitat loss and fragmentation is the first factor which affects the wild life.
2. Pollution also plays an important role.

**1.18 Conservation of biodiversity****1) In- situ conservation**

It involves the protection of fauna and flora within its natural habitat, where the species normally occurs.

**Important in-situ conservation**

In- situ conservation	Numbers available
biosphere reserves	7
National parks	80
wildlife sanctuaries	492
Gene sanctuary	120



## Environment and Sustainability

### i. Biosphere reserves

- It covers large area, more than 5,000 sq.Km.
- It protects endangered species for long time.
- It serves as a site of recreation and tourism.
- It is also useful for educational and research purposes.



**Fig 1.6 Biosphere reserves**

### Remedies:

Adequate crop and cattle compensation schemes must be started. Cropping pattern should be changed near the forest.

(eg) Examples of Biosphere reserves of India:

Name of biosphere	State
Nanda Devi	UP
Manas	Assam
Nilgiri	Tamilnadu, Karnataka, Kerala
Nokrek	Meghalaya

### ii. National parks

- It is an area dedicated for the conservation of wild life along with its environment.
- It covers about 100 to 500 sq.Km.

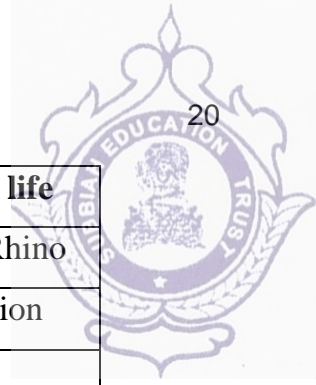

## Environment and Sustainability

Name of National parks	State	Important wild life
Kaziranga	Assam	One horned Rhino
Gir National Park	Gujarat	Indian Lion
Periyar	Kerala	Elephant
Sariska	Rajasthan	Tiger

**Role of national park:**

- It is used to protect, propagate and develop the wild life.
- It is used as tourism without affecting the environment.

**Fig 1.7 National parks****iii. Wildlife sanctuaries**

- It is an area which is reserved only for the conservation of animals.
- At present we have 492 wildlife sanctuaries.

Name of sanctuary	State	Important wild life
Mudamalai	Tamil Nadu	Elephant, tiger, leopard
Vedanthangal	Tamil Nadu	Water birds

**Role of wildlife sanctuaries**

- It protects animals and birds.
- It allows the operation such as harvesting of timber, collection of forest products etc.

**iv. Gene sanctuary**

- It is an area which is reserved only for the conservation of plants.
- (eg) Gene sanctuary for citrus, Gene sanctuary for pitcher plant

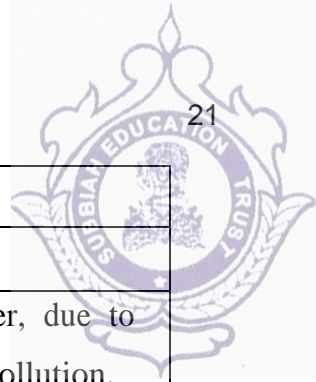

## Environment and Sustainability

Advantages	Disadvantages
<ul style="list-style-type: none"> <li>It is very cheap and convenient method.</li> </ul>	<ul style="list-style-type: none"> <li>A large area is required.</li> </ul>
<ul style="list-style-type: none"> <li>The species gets adjusted to the natural disaster.</li> </ul>	<ul style="list-style-type: none"> <li>Maintenance is not proper, due to the shortage of staff and pollution.</li> </ul>

**2) Ex- situ conservation**

It involves the **protection of fauna and flora outside** the natural habitat.

**Role of ex-situ conservation:**

- It involves maintenance and breeding of endangered plant and animal species under controlled conditions.
- It prefers the species which are more important to man in near future.
- It identifies the species which are at more risk of extinction.

(eg) **Botanical gardens, seed banks, microbial culture collections, tissue and cell cultures, museums, zoological gardens.**

**Methods:**

- National Bureau of Plant Genetic Resources (NBPGR):** It is in Delhi, where cryopreservation technique is used.
- National Bureau of Animal Genetic Resources (NBAGR):** it is in Haryana, where it preserves the semen of domesticated bovine animals
- National Facility for Plant Tissue Culture Repository (NFPTCR):** It is in Delhi, where the varieties of crop plants or trees are preserved

**Advantages:**

- Breeding of hybrid species is possible.
- The species can survive longer.



### Environment and Sustainability

- The quality of offspring may be improved by genetic techniques.
- Survival of endangered species is increased.

### **Disadvantages:**

- It is an expensive method.
- The freedom of wildlife is lost.
- The species cannot survive in natural environment.
- It can be adapted only for few kind of species.



Environment and Sustainability

### 1.19 Two mark questions

#### 1. Define environment.

Environment is defined as the sum of total of all the living and non-living things around us influencing one another.

#### 2. What are all the categories of environment?

The main categories of environment are biotic and abiotic environments. The abiotic environment can further be classified into atmosphere (air), lithosphere (soil), and hydrosphere (water). The biotic environment is called as biosphere.

#### 3. Write down the scope of environmental studies.

- To get an awareness and sensitivity of the environment and its related problems.
- To develop skills for identifying and solving Environmental problems.
- To know the necessity of conservation of natural resources.

#### 4. What are the importance environmental studies?

- By the environmental studies, people will understand the need of development without destruction of environment
- Through the studies, people can gain the knowledge and different environmental hazards.
- Environmental studies have a direct relation to the quality of life we live.

#### 5. Define ecosystem.

A group of organisms interacting among themselves and with environment is known as ecosystem.

#### 6. Define Ecology

It is the study of interactions among organisms or a group of



Environment and Sustainability

**organism with their environment.** The environment consists of both biotic and abiotic components

(eg) animals cannot synthesis their food directly but depend on the plants directly or indirectly.

### 7. What is energy flow?

The flow of energy from producer level to top consumer level is called energy flow.

### 8. How does a biome differ from ecosystem?

Biomes are very large ecological areas on the earth surface, with flora and fauna adapting to their environment.

A group of organisms interacting among themselves and with environment is known as ecosystem.

### 9. Define biodiversity and give its significance.

Bio-Diversity is defined as” **the variety and variability among all groups of living organisms and the ecosystem in which they occur.**”

#### Significance:

- Biodiversity is very important to human life because we depend on plants, animals and micro-organisms.
- It protects fresh air, clean water and productive land.

### 10. Give the classification of biodiversity.

1. Genetic diversity	2. Species diversity	3. community diversity
The diversity within the species is called genetic diversity.	Diversity between different species is called species diversity.	The diversity at the ecological (or) habitat level is known as ecosystem diversity.
(eg) rice varieties.	(eg) Plant species Animal species	(eg) River ecosystem

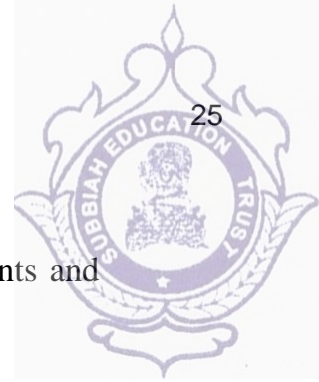

Environment and Sustainability

**11. Define red data book.**

- It is the book that contains the list of endangered species of plants and animals.
- It gives the warning signal for those species which are endangered and if not protected they become extinct in near future.

**12. Define endemic species. Give eg.**

The species which are found only in a particular region are known as endemic species. (eg) *Sapria himalayana*, Monitor lizards, reticulated python, Indian salamander etc.

**13. Define endangered species. Give eg.**

A species is said to be endangered, when its number has been reduced to a critical level. (eg) Reptiles – tortoise, python, Birds – peacock, pelican.

**14. India is a mega diversity nation. Account.**

India is one of the 12 mega diversity countries in the world. It has 89,450 animal species and 47,000 plant species.

**15. What are the important hot spots in India?**

The major hot spots of India are, (i) Eastern Himalayas (ii) Western Ghats

**16. What are the criteria for recognizing hot spots?**

- The richness of the endemic species is the primary criterion for recognizing hot spots.
- The hot spots should have a significant percentage of specialized species.
- It should contain important pools of plants of potentially useful plants.



Environment and Sustainability

**1.20 Part –B & C Questions**

1. Explain in detail the structure and component of an ecosystem.
2. Write short notes on ecological succession
3. Write short notes on threats to bio diversity
4. Explain the In-situ and Ex-situ conservation of biodiversity.
5. Discuss the values of Bio-diversity

**UNIT-II****ENVIRONMENTAL POLLUTION****2.1 Introduction**

It is defined as, “**The unfavourable alteration of the surroundings which brings about changes in quality of air, water and land.**”

**Pollutants**

Pollutants are undesirable substances which cause harm to life and property. (eg) SO<sub>2</sub>, NO, DDT, Pb, Sewage waste etc.

**Types of pollutants**

<b>1. Bio-degradable pollutants</b>	<b>2. Non-degradable pollutants</b>
The pollutants which decompose rapidly by natural processes. (eg) Animal and plant matter.	The pollutants which do not decompose or decompose slowly in the environment (eg) Plastic wastes

**2.2 Water pollution**

It is defined as “**The alternation in physical, chemical & biological characteristics of water which causes harmful effects on humans and aquatic life.**”

The major pollutants are sewage, effluents, and bacteria.

<b>Pollutant</b>	<b>Major sources</b>	<b>Effects</b>
<b>Infections Agents</b> Bacteria, virus, protozoa	Human and animal waste.	Variety of diseases.
<b>Oxygen demanding wastes</b> Animal manure & Plant debris	Sewage, animal feedlots, paper mills, food processing industries.	Depletion of DO in water. This causes death of aquatic life.

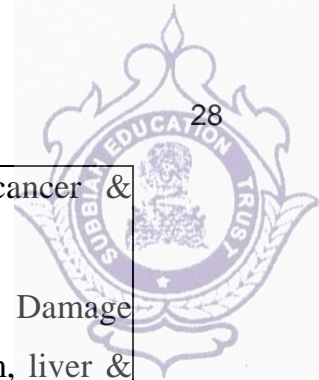

## Environment and Sustainability

<b>Inorganic Chemicals</b> chemicals like acids, toxic metals like Pb, As and Se.	Industrial effluents, surface runoff, household waste.	Causes skin cancer & neck damage. Damage nervous system, liver & Kidney
<b>Organic Chemicals</b> Plastics, pesticides, detergents	Industrial effluents, household waste.	Damages nervous system, causes some cancers.
<b>Plant Nutrients</b> Nitrates, phosphates	Sewage, manure, urban fertilizer.	Lowers the O <sub>2</sub> carrying capacity of blood and kills urban children.
<b>Sediment</b> Soil, silt	Land Erosion	Reduces photosynthesis.
<b>Radioactive materials</b> Radio isotopes of I <sub>2</sub> , uranium and thorium	Nuclear power plants, mining	Genetic mutation, birth defects and certain cancers.
<b>Heat (thermal pollution)</b> Excessive heat	Electric power plants, industrial power plants.	Decrease in DO cause diseases to the aquatic organism.

**Controlling of water pollution**

1. The administration of water pollution control should be in the hands of State or Central Government.
2. Scientific techniques should be used to control of water pollution.
3. Plant trees to control pollution.
4. Highly qualified and experienced persons should be consulted from time to time for effective control of water pollution.



## Environment and Sustainability

5. Public awareness should be given through radios, television, and newspaper for preventing pollution.
6. Laws, standards and practices should be framed and modified from time to time.
7. The use of treated water or recycled water should be emphasized and encouraged.

### 2.3 Soil pollution

It is defined as “**the contaminations of the soil by human and natural activities which may cause harmful effects on living beings**”.

#### Types, sources and effects of soil pollution

<b>Pollutant</b>	<b>Major sources</b>	<b>Effects</b>
Industrial wastes	Textiles, steel, paper, cement industries, oil refineries etc.	Affects <b>human health</b> and <b>soil fertility</b> .
Urban waste	Commercial and domestic wastes. Ex. Garbage, plastics, glasses, metallic cans.	Spread <b>diseases</b> , which destroy the beneficial bacteria
Agricultural practices	Fertilizers, pesticides, and weedicides	<b>Nervous disorders, mutation</b> in man.
Radioactive pollutants	Radioactive wastes. (eg) Ba-140 I – 130, Sr – 90 etc.	<b>Cancer and genetic disorders.</b>
Biological agents	Human and animal wastes, garbage.	<b>Tuberculosis, cholera</b>



## Environment and Sustainability

### Control of soil pollution

1. Trees can be planted on barren slopes.
2. Rotate the crop pattern.
3. Bio pesticides should be used instead of toxic chemical pesticides.
4. ~~Pro~~ Proper hygienic condition.
5. Recycling and reuse of waste.
6. Public awareness programs should be imparted to educate people.
7. Toxic chemicals and pesticides like **DDT, BHC** etc should be **banned**.
8. Nuclear explosions and improper disposal of radioactive wastes should be banned.
9. Open dumping should be avoided.

### 2.4 Air pollution

Air pollution is defined as the presence of one (or) more contaminants like dust, smoke, mist and odour in the atmosphere which causes damage to plants, animals and human beings.

#### Common Air pollutants, sources and their effects

Pollutant	Major sources	Effects
<b>Carbon monoxide: (CO)</b> Colourless, odourless and poisonous gas.	Burning of fossil fuels, automobile exhaust etc.	Headache, bronchitis, respiratory irritation, loss of appetite, suffocation.
<b>Oxides of Nitrogen (NO, NO<sub>2</sub>)</b>	Power stations, automobile exhaust etc.	Headache, bronchitis, respiratory irritation, loss of appetite, affects

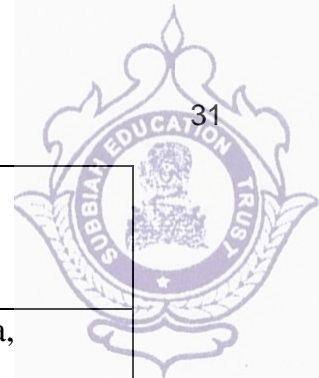

## Environment and Sustainability

		the enamel of teeth.
<b>Oxides of sulphur</b>  Colourless and irritating gas.	Burning of coal and petroleum products.  Byproducts from oil refineries.	Suffocation, asthma, chronic bronchitis.
<b>Photo chemical smog</b>	Chemical reaction between hydrocarbons and oxides of N by sunlight.	Breathing problems, eye, nose and throat irritation.
<b>Ozone (O<sub>3</sub>)</b>  The irritating gas with an unpleasant odour.	Chemical reaction between volatile organic compounds and oxides of N.	Irritation of eyes, respiratory tracts and lungs.
<b>Suspended particulate Matter (SPM)</b>  It includes varieties of particles and droplets.	Burning diesel and other fuels, agriculture and construction etc.	Nose and throat irritation, lung damage, asthma, reproductive problems and cancer.
<b>Lead (Pb)</b>  Solid toxic metal	Paint, storage batteries, leaded petrol.	Mental retardation, health problems, cancer

**Controlling air Pollution Controlling at the sources:**

1. Use only unleaded petrol
2. Use fuels that have low sulphur and ash.
3. Plant trees.
4. Industrial waste should be disposed outside the city.
5. Use catalytic converters.



Environment and Sustainability

**Control Measures in industries:**

1. Emission rates should be restricted to permissible levels in all industries.
2. Use air pollution control equipment.
3. Monitoring of the atmospheric pollutants.
4. Scrubber, cyclone separator, bag house filter and electrostatic precipitators should be used.
5. The disposal of the collected air pollutants is equally important for controlling air pollution.

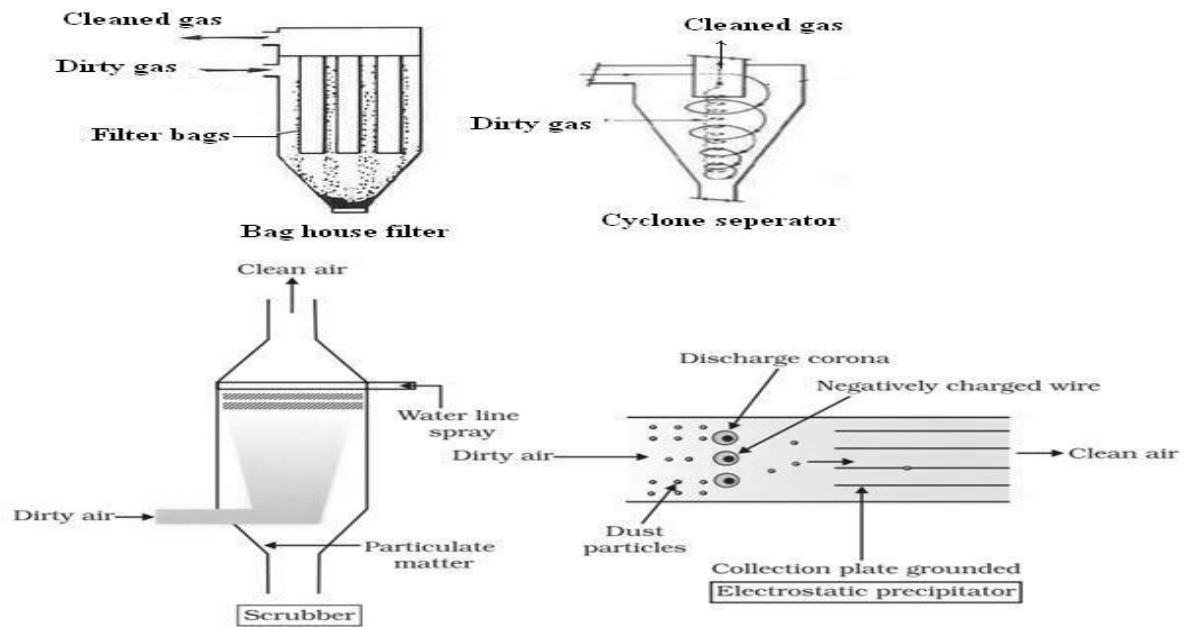

**2.5 Noise Pollution**

It is defined as “**unwanted sound, unpleasant or disagreeable sound that causes dangerto all living beings.**”

**Types, sources and effects of noise pollution**

<b>Pollutant</b>	<b>Major sources</b>	<b>Effects</b>
<b>Industrial noise</b>	Compressors, generators, grinding mills, furnaces.	Psychological and pathological

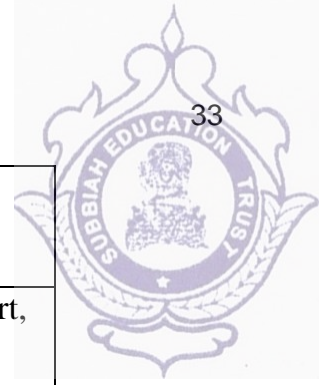

## Environment and Sustainability

		disorders.
<b>Domestic noise</b>	Transistors, radio, TV, other musical instruments	Headache, pain in heart, Emotional disturbances, hearing loss.
<b>Traffic noise</b>	Continuous movement of vehicles causes traffic noise. (eg) Those who live near the roads, railway links, and airports	Nervous breakdown, tension etc.

**Control measures:**

- ❖ **Source Control** - Modification of source such as acoustic treatment.
- ❖ **Oiling:** Proper oiling will reduce the noise.
- ❖ **Planting of trees:** Planting of trees like neem, tamarind, coconut etc near schools hospitals.
- ❖ **Selection of machinery:** Careful selection of machine tools and equipments.

**2.6 Solid waste management**

**Any material that is thrown away or discarded as unwanted is considered as solid waste.**

**Types of solid waste****1. Urban waste (or) municipal waste.**

**Biodegradable wastes:** E.g. food, vegetables, Tea leaves, dried leaves etc.

**Non-biodegradable waste:** Cans, polythene bags

2. **Industrial waste:** Nuclear power plants generate radioactive wastes, acid, alkalis, scrap metals.



Environment and Sustainability

### 3. **Hazardous waste:** Reactive waste like gun powder, bandages, human tissues

etc.

#### **Process of solid waste management / Wasteshed management**

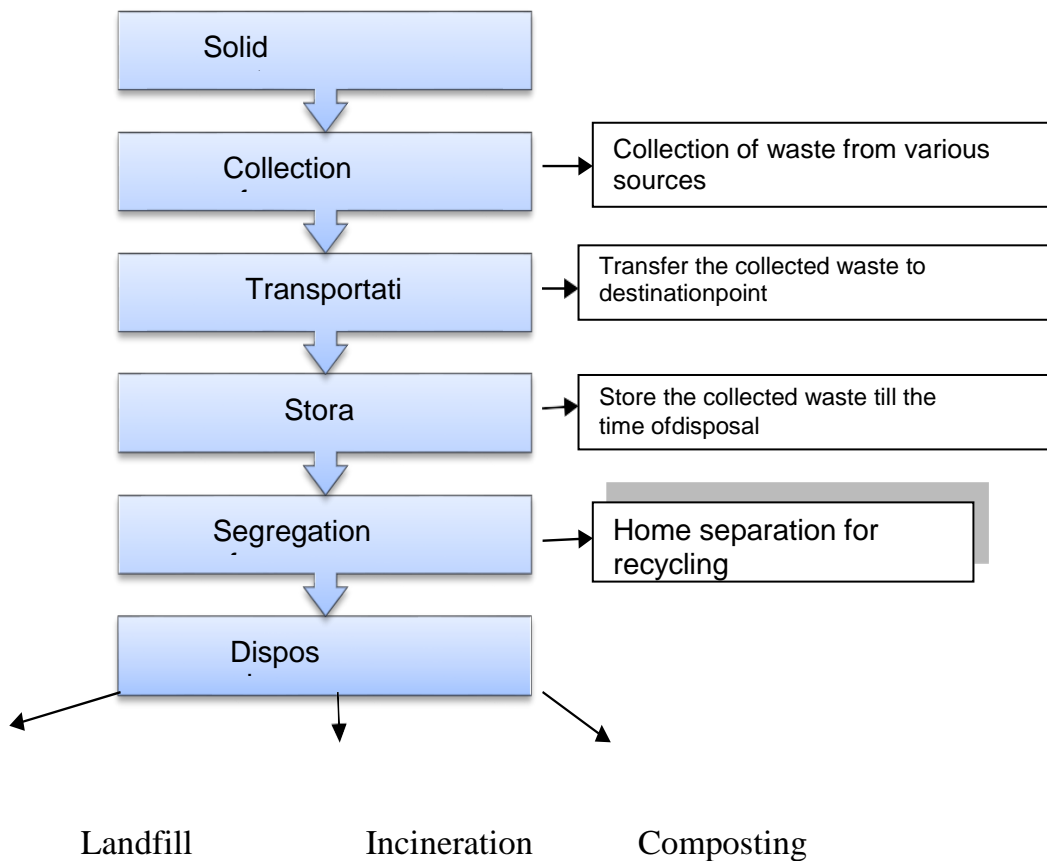

#### **Steps involved in solid waste management**

##### **I. Reduce, reuse, recycle, recovery and refuse: (5R)**

- **Reduce the use of raw materials:**

If the usage of raw materials is reduced, the generation of waste also gets reduced.

- **Reuse of waste materials:**

Discarded refillable containers can be reused. Waste generation during manufacture of rubber bands is reduced by making rubber bands from



Environment and Sustainability  
discarded cycle tubes.

- **Recycling of materials.**

Recycling is the reprocessing of discarded materials into new useful products. Eg. Old aluminum cans, glass bottles are melted into new cans and bottles.

- Recovery
- Refuse

### Methods of disposal of municipal solid wastes

#### a. Land Fill:

- Solid wastes are placed in sanitary land fill system in alternate layers of **80cm** thick refuse, covered with earth of **20cm** thickness.
- After **2 or 3 years** solid waste volume shrinks by **25-30%**.
- The land is used for parks, roads and small buildings.

Advantages	Disadvantages
<ul style="list-style-type: none"> <li>• Simple and economical</li> </ul>	<ul style="list-style-type: none"> <li>• Large area needed.</li> </ul>
<ul style="list-style-type: none"> <li>• Converts low lying, marshy waste land into useful areas.</li> </ul>	<ul style="list-style-type: none"> <li>• Bad odour, if landfills are not properly managed.</li> </ul>

#### b. Incineration

- In this method the municipal solid wastes are burnt in a furnace called **incinerator**.
- The combustible substances and noncombustible substances are separated before feeding into incinerator.
- The left out ashes and clinkers from the incinerator may be



## Environment and Sustainability

about **10-20 %** which is disposed by land fill.

- The heat produced during burning is used as steam power for generation of electricity.
- The wet solid waste is dried in preheaters.
- The temperature maintained is about **700°C** to **1000°C** when electricity is to be generated.

Advantages	Disadvantages
1. Requires little space	1. Capital and operational cost is high.
2. Hygienic point of view, it is safest.	2. Formations of smoke, dust and ash causes air pollution.

### c. Composting

- In this method, bulk organic waste is converted into manure by biological action.
- Compostable waste is dumped in underground trenches in layer of **1.5 m** and it is covered to **20 cm** and left for decomposition.
- Microorganism like *actinomycetes* is added for active decomposition.
- Within two to three days, biological action starts.
- The organic matter is decomposed by actinomycetes.
- The temperature of the compost increases by **75°C** and finally the refuse is converted to a brown coloured powder known as **humus**.
- It is used in agriculture.
- The compost contains N, P and other minerals.

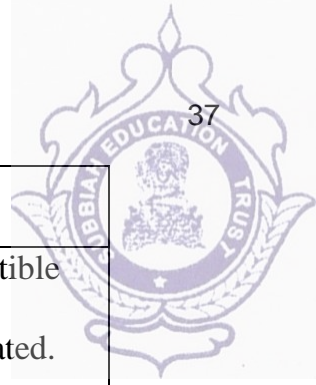

## Environment and Sustainability

Advantages	Disadvantages
➤ Recycling occurs.	➤ The non-combustible wastes cannot be treated.
➤ Number of industrial solid wastes can also be treated.	

## 2.7 Hazardous waste management

Hazardous waste management is a process to ensure the storage, treatment and disposal of dangerous waste is conducted in a manner that protects the health and safety of people and the environment.

### Types

- ✓ Toxic — This includes poisons with immediate, long-term and/or chronic health effects.
- ✓ Reactive — This type of waste violently reacts with elements like air or water.
- ✓ Ignitable — This includes materials flammable at low temperatures.
- ✓ Corrosive — This type of waste eats away at other materials like metal.

### Management

- Hazardous waste can be treated by chemical, thermal, biological, and physical methods. Chemical methods include ion exchange, precipitation, oxidation and reduction, and neutralization.
- Among thermal methods is high-temperature incineration, which not only can detoxify certain organic wastes but also can destroy them.
- One method used to treat hazardous waste biologically is called land farming.

**2.8 E waste**

E-waste or electronic waste are broadly describes loosely discarded, surplus, obsolete, broken, electrical or electronic devices which are at the end of their useful life and need to be disposed or dismantled to recover some valuable components.

**(Egs)** Electrical and electronics devices generating e- waste are from IT & telecommunication equipment and consumer electrical / electronic products such as refrigerators, washing machines, computer and its accessories, monitors, printers, keyboards.

**Management****1. Land filling:**

It is widely used methods for disposal of e-waste. In this method, trenches are made on the flat surfaces by removing soil from the trenches and waste material is buried in it, which is covered by a thick layer of soil. Secure landfill is made using modern technique. Here they are provided with some facilities like, impervious liner made up of plastic or clay, leachate collection basin that collects and transfer the leachate to wastewater treatment plant.

**2. Incineration:**

In this controlled and complete combustion process, the waste material is burned in specially designed incinerators at a high temperature (900-1000°C)..

**3. Recycling of e-waste:**

Fridge, Washing machines, TVs, Monitors & CRT, keyboards, laptops, modems, telephones, hard drives, floppy drives, Compact disks, mobiles, fax



#### Environment and Sustainability

machines, printers, CPUs, memory chips, connecting wires & cables can be recycled.

#### 4. Re-use:

It constitutes direct second hand use or use after slight modifications to the original functioning equipment. It is commonly used for electronic equipment like computers, cell phones etc

5. Suggested Approach for e-waste disposal A strategy of "Reduce, Reuse, Recycle" should to be adopted for e-waste disposal.

### 2.9 Case Studies on occupational health and safety Management system

To help start or improve your organization's safety and health program, see the case studies listed below for lessons learned and best practices.

- The Electric Power Industry relies on Safety and Health Programs to keep workers safe on the job ([PDF](#))
- OSHA's Safety and Health Recognition Program (SHARP) recognizes small businesses that operate exemplary safety and health programs. Success stories from these programs highlight:
  - Hazards that OSHA's voluntary On-Site Consultation Program helped companies identify.
  - Methods companies implemented to correct the hazards.
  - Business practices that changed to prevent injuries and illnesses.
  - Challenges, successes, and overall impact on businesses.
- More than 60 success stories from 2008 through 2016 are presented from a wide range of industries throughout the country.

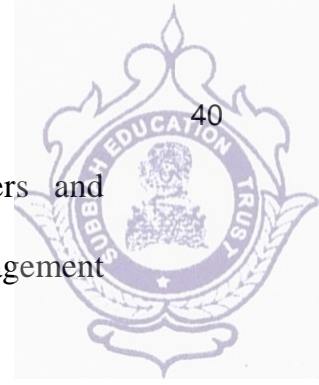

## Environment and Sustainability

- OSHA's Voluntary Protection Programs (VPP) recognize employers and workers who have implemented successful safety and health management systems.
- You can read stories highlighting successes and best practices from companies participating in VPP –21 recent stories arranged by industry - as well as 26 archived stories from 1994 to 2010.
- Each year the National Safety Council (NSC) recognizes "CEOs Who Get It" by demonstrating a personal commitment to worker safety and health. These Chief Executive Officers show the key role of management leadership in building a culture of safety.
- The Robert W. Campbell Award Business Case Studies are designed to show future business leaders the business value of environmental, health, and safety (EHS) management. Established in 2004, the award recognizes companies who are the "best of the best" in integrating EHS management into business operations. You can download materials including a business case study document, teaching notes, PowerPoint presentation, and videos for case studies on the following companies:
  - Noble Corporation
  - Johnson and Johnson
  - Alcan
  - DM Petroleum Operations
  - Fluor Hanford
  - Schneider Electric
  - Dow Chemical



Environment and Sustainability

## 2.10 Environmental protection

**Environmental protection** is the practice of protecting the natural environment by individuals, organizations and governments. Its objectives are to conserve natural resources and the existing natural environment and, where possible, to repair damage and reverse trends

Due to the pressures of overconsumption, population growth and technology, the biophysical environment is being degraded, sometimes permanently. This has been recognized, and governments have begun placing restraints on activities that cause environmental degradation. Since the 1960s, environmental movements have created more awareness of the multiple environmental problems. There is disagreement on the extent of the environmental impact of human activity, so protection measures are occasionally debated.

## 2.11 Environment protection act 1986

**Aim:** The main aim of water (air, environment) act is protecting the water from all kinds of pollution and preserving the quality of water (air, environment).

### Important features of Environment Protection Act

1. Environment Protection Act give suggestions for the establishment of Central and State board for prevention of water pollution.
2. Central Board provides technical assistance and guidance to State Boards.
3. The State Boards should look after the emission of environment pollutants from industrial units or automobiles or other sources.
4. State Board should collect information related to environment pollution and should function as on rule.
5. State Board should examine the manufacturing process and the control equipment



Environment and Sustainability  
to verify whether they meet the standards prescribed.

6. Central Government should advise the state Government, to declare certain heavily polluted areas to avoid the burning of waste products which cause air pollution in such areas.

7. Violation of law is punishable with imprisonment for 1.5 to 6 years or fine up to Rs.10, 000 or both. 8. If the violation continues, an additional fine of Rs.5000/- per day may be imposed for the entire period.

**2.12 Part-A****1. Define Pollution.**

It is defined as, “The unfavorable alteration of the surroundings which brings about changes in quality of air, water and land.”

**2. What are the types of pollutants?**

<b>Bio-degradable pollutants</b>	<b>Non-degradable pollutants</b>
The pollutants which decompose rapidly by natural processes.	The pollutants which do not decompose or decompose slowly in the environment
(eg) Animal and plant matter.	(eg) Plastic wastes

**3. Define BOD and COD.**

BOD is the amount of oxygen required for the biological decomposition of organic matter present in the water.

COD is the amount of oxygen required for the chemical oxidation of organic matter using some oxidizing agent like  $K_2Cr_2O_7$ .

**4. Define hazardous waste.**

Waste like toxic chemicals, radioactive or biological substance which contribute to an increase in mortality or in serious irreversible illness to human and environment are called hazardous waste.

**5. What is photochemical smog**

Photochemical smog is a **brownish smoke like appearance**. It is mainly due to the chemical reactions among nitrogen oxides and hydrocarbon by sun light.

**6. What is air pollution**

Air pollution is defined as the presence of one (or) more



## Environment and Sustainability

contaminants like dust, smoke, mist and odour in the atmosphere which causes damage to plants, animals and human beings.

### 7. What is water pollution

It is defined as “The alternation in physical, chemical & biological characteristics of water which causes harmful effects on humans and aquatic life.”

### 8. What is soil pollution

It is defined as “the contaminations of the soil by human and natural activities which may cause harmful effects on living beings”.

### 9. What is noise pollution

It is defined as “unwanted sound, unpleasant or disagreeable sound that causes danger to all living beings.”

### 10. What are E Waste

E-waste or electronic waste are broadly describes loosely discarded, surplus, obsolete, broken, electrical or electronic devices which are at the end of their useful life and need to be disposed or dismantled to recover some valuable components.

### 11. What is Hazardous waste management

Hazardous waste management is a process to ensure the storage, treatment and disposal of dangerous waste is conducted in a manner that protects the health and safety of people and the environment.



Environment and Sustainability

**2.13 Part-B & C questions**

1. Explain the sources and effects and control measures of air pollution.
2. Explain the sources and effects and control measures of noise pollution.
3. Explain the sources and effects and control measures of soil pollution.
4. Explain in detail the Solid waste management techniques
5. Explain the sources and effects and control measures of water pollution.
6. Explain E Waste management techniques



## Energy Management and conservation

### 3.1 Energy Management

**Energy management** includes planning and operation of energy production and energy consumption units as well as energy distribution and storage.

Energy management is the proactive, organized, and systematic coordination of procurement, conversion, distribution, and use of energy to meet the requirements, taking into account environmental and economic objectives.

**To make things simple**, we can define Energy management as a process that involves **optimization of energy use for the best possible outcomes** and taking steps for its conservation. It also includes planning related to the **production of energy** and its **storage for future usage**. So, the ultimate aim of this process is not only to save the cost but also to achieve complete environmental sustainability.

#### Objectives

1. Minimizing wastage of energy value without affecting production and quality.
2. He is minimizing environmental impact and change.
3. We are reducing fuel requirements per unit of energy output.
4. To make the best possible use of hard-earned energy in all methods, organizations.



## Environment and Sustainability

5. Establishing short, medium, and long-term plans as per demand requirements.

### **Need**

1. To reduce the emission of carbon dioxide in the atmosphere, energy efficiency must be increased and renewable energy sources should be used more.
2. We can save a lot of money by using and installing better equipment and efficient use of equipment.
3. We can achieve a more comfortable working environment by using energy efficiently (e.g., by not using overheated rooms).
4. This is a direct way to identify energy values.

### **Principle**

1. Identifying and tracking energy use patterns is the first step in any energy program. Without knowing how, when and where energy is used, there is no way to gauge the relative importance of energy management projects.
2. More energy savings may be obtained by simply controlling a system's use (e.g., lighting) than by installing more efficient components (e.g., T-8 lamps and electronic ballasts).
3. Most successful energy management programs are found in the best-managed and maintained facilities, not in those with the greatest quantity of technological equipment.



## Environment and Sustainability

4. Good maintenance practices and good energy management go hand in hand. Some of the highest rates of return on energy conservation are generated simply by performing maintenance.

### Steps

#### **Step 1: Get commitment and appoint an energy manager**

The first step is to make sure that senior management understands the business benefits of an energy strategy and supports the proposed energy saving measures. Appointing an energy manager demonstrates that the business takes its energy saving goals seriously. The energy manager's role is to:

- Lead the energy team in their energy saving actions
- communicate and emphasise to colleagues the importance of the energy strategy

The energy manager needs experience and training to be effective - relevant professional qualifications are available. Depending on the size of your organisation the role might be full or part time.

#### **Step 2: Understand the issues**

To manage energy use effectively you need to have a clear understanding of:

- how your business is currently using energy
- how your energy usage compares with other businesses



## Environment and Sustainability

- attitudes within your business towards adopting energy saving measures

### **Step 3: Plan and organize**

Start by carrying out an energy survey to see where you can make energy savings. Use all the information you gather to produce an energy policy and identify long, medium and short term energy saving targets.

### **Step 4: Develop an action plan**

Once you have identified your targets, draw up an action plan outlining the practical steps your business will take to achieve your goals. Give individuals responsibility for specific tasks.

### **Step 5: Involve your staff**

It's very important to get support for the energy strategy from:

- key decision makers
- senior management
- staff at all levels of the business

Carrying out training and highlighting the strategy's benefits all help to boost staff participation.

### **Step 6: Control, monitor and report**

Monitor your performance regularly to check that you're making progress towards your energy saving goals. Put in place procedures to make sure your systems will carry on operating efficiently and continue to make



Environment and Sustainability

savings in the future. Let staff know how progress towards achieving targets

is going - this helps to keep them motivated.

### 3.2 Energy conservation

**Energy conservation** is the effort to reduce wasteful energy consumption by using fewer energy services. This can be done by using energy more effectively (using less energy for continuous service) or changing one's behavior to use less service (for example, by driving less). Energy conservation can be achieved through efficient energy use, which has a number of advantages, including a reduction in greenhouse gas emissions and a smaller carbon footprint, as well as cost, water, and energy savings.

#### Objectives

- To achieve and maintain optimum energy procurement and utilisation, throughout the organization
- To minimise energy costs.
- To minimise environmental effects.
- To reduce energy conservation.
- To lower the overall green house gas emission.

#### Law of conservation of energy

The principle of energy conservation states that **energy is neither created nor destroyed**. It may transform from one type to another.

According to this, the total energy of an isolated system remain constant



## Environment and Sustainability **Importance**

- We use energy faster than it can be produced - Coal, oil and natural gas - the most utilised sources take thousands of years for formation.
- Most of the energy sources we use cannot be reused and renewed - Non renewable energy sources constitute 80% of the fuel use.
- We save the country a lot of money when we save energy - About 85 per cent of our crude oil needs are met from imports which costs about Rs. 8 lakh crore annually
- We save our money when we save energy - Imagine your savings if your LPG cylinder comes for an extra week or there is a cut in your electricity bills
- We save our energy when we save energy - When we use fuel wood efficiently, our fuel wood requirements are lower and so is our drudgery for its collection
- Energy saved is energy generated - When we save one unit of energy, it is equivalent to 2 units of energy produced
- Save energy to reduce pollution - Energy production and use account to large proportion of air pollution and more than 83 percent of greenhouse gas emissions

### **Ways of conserve energy**

- Adjust your day-to-day behaviors
- Replace your light bulbs
- Use smart power strips



## Environment and Sustainability

- Install a programmable thermostat
- Use energy-efficient appliances
- Reduce water heating expenses
- Install energy-efficient windows
- Upgrade your HVAC system
- Weatherize your home
- Insulate your home
- Wash your clothes in cold water when possible
- Replace or clean your air filters
- Use your toaster oven instead of your oven
- Use natural light
- Dress appropriately for the weather inside and outside

### **3.3 New energy sources**

1. Hydrogen
2. Ozone thermal energy
3. Tidal Energy
4. Geothermal energy
5. Solar energy
6. Wind Energy
7. Biomass energy
8. Artificial intelligence in energy sector



## Environment and Sustainability

### 9. Photovoltaics

10. Distributed energy storage system (DESS)

11. Grid integration

12. Space technologies

13. Norwegian Crystals

14. Algal Bio-fuels

15. Body heat

16. Dance floors

### **3.4 Need of new energy sources**

Fossil fuels and nuclear energy are the important resources used to meet most of our energy needs today. They are expected to be widely used in the near future. However, fossil and nuclear energy resources are non-renewable and will someday be exhausted while their continued use poses environmental risks related to air pollution, global climate change, land use and waste disposal. These issues have stimulated the search for new energy sources for producing and using energy.

### **3.5 Different types of energy sources**

#### **1. Hydrogen**

The fuel that has potential of being widely used in the future is hydrogen gas. Like natural gas, hydrogen can be burned to heat buildings, cook food and produce electricity in power plants. Hydrogen has a high calorific value. It is non-polluting because the combustion product is water.



Environment and Sustainability



Hydrogen gas can be compressed in a fuel tank and use to power cars and buses

### Sources of hydrogen

- Plentiful hydrogen is available from water. Water can be split into gaseous hydrogen and oxygen by an electrolytic process.
- Hydrogen can be produced from natural gas and biomass resources.
- Ethanol reacts with high temperature steam to produce hydrogen.
- Microbes such as green algae consume water in the presence of sunlight and produce hydrogen as a byproduct.

### Hydrogen fuel cell

Water can be separated into oxygen and hydrogen through a process called electrolysis. Electrolytic processes take place in an electrolyzer, which functions much like a fuel cell in reverse—instead of using the energy of a hydrogen molecule, like a fuel cell does, an electrolyzer creates hydrogen from water molecules

Hydrogen is a clean fuel that, when consumed in a fuel cell, produces only water. Hydrogen can be produced from a variety of domestic resources, such as natural gas, nuclear power, biomass, and renewable power like solar and wind. These qualities make it an attractive fuel option for transportation and electricity generation applications. It can be used in cars, in houses, for portable power, and in many more applications.

Hydrogen is an energy carrier that can be used to store,



## Environment and Sustainability

move, and deliver energy produced from other sources.

Today, hydrogen fuel can be produced through several methods. The most common methods today are natural gas reforming (a thermal process), and electrolysis. Other methods include solar-driven and biological processes.

### **Disadvantages**

- Difficulties in storing enough hydrogen for motor vehicle to run long distance.
- Infrastructure to refuel these vehicles.
- Highly inflammable and explosive in nature.
- Safe handling if required.

## **2. Ozone thermal energy**

Ocean thermal energy conversion (OTEC) is a process or technology for producing energy by harnessing the temperature differences (thermal gradients) between ocean surface waters and deep ocean waters.

### **Types**

There are three types of OTEC systems: closed-cycle, open-cycle, and hybrid.

### **Uses**

Ocean Thermal Energy Conversion (OTEC) is a technology for generating renewable energy that uses the temperature differential between the deep cold and relatively warmer surface waters of the ocean to generate baseload electricity.



### 3. Tidal Energy

Tidal energy is a renewable source of energy that is generated from a natural source, that is, water. Therefore, it could be considered a significant part of the hydro energy generation process. The tides, so generated, due to the gravitational pull of the moon and sun over a period of time helps in the generation of tidal energy. The presence of the tidal currents contributes to moving the blades of the turbine and hence, generating electricity from the tides.

#### Types of Tides

**Spring Tides:** It usually occurs on full moon nights when the sun, moon, and the earth are aligned in a straight line, resulting in high tides due to the strong gravitational fields.

**Neap Tides:** It usually occurs on quarter moon nights when the gravitational pull of the sun and the moon are extremely weak due to the counteracting effects of each other. This results in the generation of the weak tides marked by the negligible difference between the high and the low tides.

#### Advantages

- Environment-friendly.
- A highly predictable energy source.
- High energy density.
- Operational and maintenance costs are low.
- An inexhaustible source of energy.



Environment and Sustainability

#### **4. Geothermal energy**

Geothermal energy is the heat produced deep in the Earth's core. Geothermal energy is a clean, renewable resource that can be harnessed for use as heat and electricity. Geothermal energy is heat that is generated within the Earth.

##### **Advantages**

- There are plenty of hot springs and natural pools across the world that emit geothermal energy. The water from such a natural source of geothermal energy is commonly used for bathing, warmth, and cooking.
- GHPs powered heating, and air-conditioning systems are more efficient as they use 25 to 50% less electricity than conventional systems. Ultimately, there is a decrease in greenhouse gas emissions as well.
- Many buildings, sidewalks, and parking lots are heated using geothermal energy.
- Also, known as a green source of energy because it does not release hazardous greenhouse gases. Thus, it is safe for both environmental and human health.
- Geothermal energy systems can adjust to various conditions.



#### Environment and Sustainability

- One of the best advantages of geothermal energy is that cold countries use geothermal energy to heat greenhouses or heat water for irrigation.
  
- Iceland mostly uses geothermal energy to heat buildings and water using magma and molten rock resources.
  
- It is a renewable, carbon-free, and sustainable source of energy. The Earth will continuously transmit heat from its core for billions of years.

### **5. Solar energy**

Solar energy is any type of energy generated by the sun. Solar energy is created by nuclear fusion that takes place in the sun. Fusion occurs when protons of hydrogen atoms violently collide in the sun's core and fuse to create a helium atom. Solar energy is a renewable energy source and reduces carbon emissions

Solar energy is clean. It creates no carbon emissions or other heat-trapping “greenhouse” gases. It avoids the environmental damage associated with mining or drilling for fossil fuels. Furthermore, solar energy also uses little to no water, unlike power plants that generate electricity using steam turbines.

#### **Advantages**

- (i) Solar energy is clean & green energy
- (ii) Not dependent on other sources of Energy



#### Environment and Sustainability

- (iii) Non-maintenance
- (iv) Safer than Other
- (v) Renewable Energy
- (vi) Electricity Bill Reduction
- (vii) Maximum Usage
- (viii) Technology Development

### 6. Wind Energy

Wind power or wind energy describes the process by which the wind is used to generate mechanical power or electricity. Wind turbines convert the kinetic energy in the wind into mechanical power.

#### Advantages

- It does not cause any air pollution.
- It is very cheap and economic.
- It is renewable.
- It is used to operate water pump, flour mills and electric generators.

### 7. Biomass energy

Biomass energy is energy generated or produced by living or once-living organisms. The most common biomass materials used for energy are plants, such as corn and soy, above. The energy from these organisms can be burned to create heat or converted into electricity.



## Environment and Sustainability

(eg) Wood, crop residues, seeds, cattle dung, sewage, agricultural

waste

### Significance

- Biomass is always and widely available as a renewable source of energy
- It is carbon neutral.
- It reduces the overreliance of fossil fuels.
- Is less expensive than fossil fuels.
- Biomass production adds a revenue source for manufacturers.
- Less garbage in landfills.

## 8. Artificial intelligence in energy sector

Artificial intelligence is used to forecast demand, manage the distribution of resources, to ensure that power is available at the time and place it is needed with a minimum of wastage. AI plays an essential role in the world transition to clean energy. AI is particularly important in the renewable energy industry, where it often cannot be stored for long periods of time and has to be used close to the time and location where it is regenerated.

## 9. Photovoltaics

Photovoltaics is the conversion of light into electricity using semiconducting materials that exhibit the photovoltaic effect, a phenomenon studied in physics, photochemistry, and electrochemistry. The photovoltaic effect is commercially used for electricity generation and as photo sensors.



## Environment and Sustainability Uses

- Photovoltaic systems can be used to supply electricity for:
- Telecommunication repeater stations.
- Water pumps.
- Navigational aids.
- Laptop computers.
- Cottages and remote residences.
- Parks in remote regions.
- Supplying occasional power.

### **10. Distributed energy storage system (DESS)**

Distributed energy storage system is a packaged solution that store energy for use at a later time. A system is provided with two component.

- i) DC charge batteries
- ii) Bidirectional inverter.

Its major role is to prevent power fluctuation and power quality problems.

### **11. Grid integration**

It is the practice of developing efficient ways to deliver variable , renewable energy to the grid.

### **12. Space technologies**

Space based energy technology like,



## Environment and Sustainability

- i) Harvesting hydrogen from the moon to power fuel cell on the earth.
- ii) Orbiting solar rays that absorb around the clock direct sun light and send the energy back down to stations on the ground via radio or microwaves,

Are being developed as the new energy technology.

### **13. Norwegian Crystals**

- i) Low carbon mono crystalline silica ingots is a type of crystal used for high performance photovoltaic performances.
- ii) Gallium dots ingots, that increases the life time of the solar cells.

### **14. Algal Bio-fuels**

Algae is an alternative of liquid fossil fuels. It offers huge commercial potential like fossil fuel, algae fuel releases carbon dioxide when burn. But unlike fossil fuel, the CO<sub>2</sub> released by algae fuel is renewed from the atmosphere via photosynthesis as the algae or plant grew.

The impact of algal biofuels on the atmosphere is much lower. Algal fuel production has minimal impact on land and water resources. It can be produced using sea water or even grey waste water.

### **15. Body heat**

The body heat, liberated by humans in the crowded area like central station, market place. Is channelled through the stations vent system.



## Environment and Sustainability

Then it is used to warm up water in underground tanks and pumped through the heating system.

### 16. Dance floors

The kinetic energy of the dance floor is converted to electricity that lights up the dance floor itself.

**Pavegen**, a London based company is demonstrating with its development of the energy harvesting smart street.

### 3.6 Application of hydrogen energy

- (i) Hydrogen fuel cells produce electricity
- (ii) Burning hydrogen for electricity generation
- (iii) Hydrogen use in vehicles
- (iv) Hydrogen is used in many industrial processes
- (v) Hydrogen is used for exploring outer space

#### Advantages of fuel cell

- High Efficiency- when utilizing co-generation, fuel cells can attain over 80% energy efficiency
- Good reliability- quality of power provided does not degrade over time.
- Noise- offers a much more silent and smooth alternative to conventional energy production.
- Environmentally beneficial- greatly reduces CO<sub>2</sub> and harmful pollutant emissions.



#### Environment and Sustainability

- Size reduction- fuel cells are significantly lighter and more compact

#### **Disadvantages:**

- Expensive to manufacture due the high cost of catalysts (platinum)
- Lack of infrastructure to support the distribution of hydrogen
- A lot of the currently available fuel cell technology is in the prototype stage and not yet validated.
- Hydrogen is expensive to produce and not widely available

### **3.7 Ocean energy resources**

Ocean energy refers to all forms of renewable energy derived from the sea. There are three main types of ocean technology: wave, tidal and ocean thermal.

All forms of energy from the ocean are still at an early stage of commercialisation. Wave energy remains more costly than the other ocean technologies. Tidal range (see explanation below) has been deployed in locations globally where there is a strong tidal resource (for example La Rance in France, Sihwa in South Korea), while tidal stream (see below) has been demonstrated at pilot scale.

#### **How does it work?**

Wave energy is generated by converting the energy within ocean waves (swells) into electricity. There are many different wave energy technologies being developed and trialled to convert wave energy into electricity.

Tidal energy comes in two forms, both of which generate electricity:



## Environment and Sustainability

- Tidal range technologies harvest the potential energy created by the height difference between high and low tides. Barrages (dams) harvest tidal energy from different ranges.
- Tidal stream (or current) technologies capture the kinetic energy of currents flowing in and out of tidal areas (such as seashores). Tidal stream devices operate in arrays, similar to wind turbines.

Ocean thermal energy is generated by converting the temperature difference between the ocean's surface water and deeper water into energy. Ocean thermal energy conversion (OTEC) plants may be land-based as well as floating or grazing.

## Application

Tidal energy or tidal power is a form of hydropower that is harnessed by converting tide energy into useful forms of power. It relies on the rising and falling of sea levels and tidal energy devices convert the energy gained from tides into electricity.

### ➤ Ocean waves

Potential energy associated with ocean waves can be harnessed using modular technologies.

### ➤ Temperature gradient

Difference in thermal energy between sea surface and deep water can be harnessed by ocean. Thermal energy conversion (OTEC) process.

### ➤ Salinity gradient

At the mouth of rivers, where fresh water mixed with salt water,

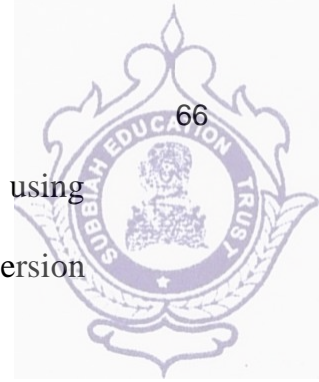

## Environment and Sustainability

energy associated with the salinity gradient can be harnessed using pressure retard reverse osmosis process and associated conversion technologies.

### ➤ **Ocean wave energy convertors**

These are the technology used to trap the mechanical energy of the wave to convert it electrical power.

### ➤ **Oscillating bodies**

Oscillating waves uses hydrolic motors or electrical generators as a power take off system.

### ➤ **Overtopping wave energy convertors**

Overtopping wave energy convertors are terminators, using the low head hydrolic turbines, convert potential energy formed by the height of accumulated water over the wave surface to electric power.

### ➤ **Ocean thermal energy**

The temperature difference between the surface level and the deeper level of the tropical ocean can be utilized to generate electricity.

## **Advantages**

- Cheaper and Efficient
- Renewable
- The sources of energy is inexhaustible
- Environment Friendly
- Abundant and Widely Available



## Environment and Sustainability

- Variety of Ways To Harness
  
- Easily Predictable

### **Disadvantages**

- Highly expensive
- Scalability issues
- High maintenance costs
- Low performance in unfavourable weather
- Highly expensive at the moment

### **3.8 Applications of tidal energy conversion**

Tidal Energy is a renewable source of energy like Solar, Geothermal, and Wind energy. Here are some of the uses of Tidal Energy.

#### **1. Tidal Electricity**

The most important use of tidal energy is the generation of Electricity, called Tidal Electricity. The electric power generated from the tides is reliable as tides are predictable and uniform in nature.

#### **2. Grain Mills**

Tidal Energy has been in use for hundreds of years. Just like the Wind Mills, Tidal Energy was used for the mechanical crushing of grains in grain mills. To crush grains. Here, the movement of the turbines powered by tidal energy was used.



### 3. **Energy Storage**

Tidal Energy is also used to store energy in hydroelectric dams, which act as large energy storage. Tidal Barrages and reservoirs can be modified to store energy.

### 4. **Provide Protection to Coast During High Storms**

Tidal Barrages are capable to prevent damage to the coast during high storms. They also serve to create easy transport between the two arms of an estuary or a bay.

### **Advantages of Tidal Energy**

1. **Renewable:**
2. **Green:** Tidal power is an environmentally friendly source of energy. It does not produce any harmful gas. One of the major benefits of tidal energy is that it utilizes a very small space for energy production.
3. **Predictable:** Tidal currents or waves are highly predictable. High and low tide develops with the ocean as per some renowned cycles. This makes it easier to develop a system with exact dimensions to produce energy, as we already have knowledge of what kind of waves the equipment will be exposed to.
4. **Effective at Low Speeds:** It is possible to generate electric power at very low speeds because the density of water is much more than that of air. Power can also be generated at a water speed of about 1 m/s.



## Environment and Sustainability

5. Tides are fluently predictable
6. Affordable to maintain
7. Reliable and renewable source of energy
8. High energy viscosity than other renewable energy forms
9. It produces no hothouse feasts or other waste
10. Vertical-axis turbines and coastal turbines are affordable to make and have a lower environmental impact
11. Tidal turbines are 80% effective, which is more advanced than solar or wind energy creators.
12. Drumfires reduce the damage of high tidal surges on the land.

## **Disadvantages of Tidal Energy**

1. **Environmental Challenges:** Tidal energy has some adverse effects on marine life. The rotating blades of the turbine are veritably dangerous. It can accidentally kill swimming ocean life, although systems like the one in Strangford feature a security medium that turns off the turbine when marine creatures approach.
2. **Tidal Turbines:** In tidal turbines, the primary concern regarding tidal energy harnesses is the blade strike and trap of marine organisms. As high-speed water increases the threat of marine lives being pushed near or through these biases.



## Environment and Sustainability

3. **Tidal Shower:** Making a shower may change the oceanfront within the bay or creek, affecting a large ecosystem that depends on tidal apartments. Inhibiting the inflow of water in and out of the bay may beget fresh turbidity and lower saltwater. It can end in the death of fish that act as a vital food source to catcalls and mammals.
4. **Tidal Lagoon:** Generally, the threat associated with tidal lagoon is blade strike on fish trying to enter the lagoon, the aural affair from turbines, and changes in sedimentation processes.

### 3.9 Geothermal Power Plant

Geothermal power is electrical power generated from geothermal energy. Technologies in use include dry steam power stations, flash steam power stations and binary cycle power stations.

#### Concept

Geothermal energy is **heat within the earth**. The word geothermal comes from the Greek words geo (earth) and therme (heat). Geothermal energy is a renewable energy source because heat is continuously produced inside the earth. People use geothermal heat for bathing, to heat buildings, and to generate electricity.

#### Origin

**The first geothermal power plant was built in 1904 in Tuscany, Italy**, where natural steam erupted from the earth. Flash steam plants take high-pressure hot water from deep inside the earth and convert it to steam that drives generator turbines

## Environment and Sustainability Types

- **Dry steam plants** use steam directly from a geothermal reservoir to turn generator turbines. The first geothermal power plant was built in 1904 in Tuscany, Italy, where natural steam erupted from the earth.

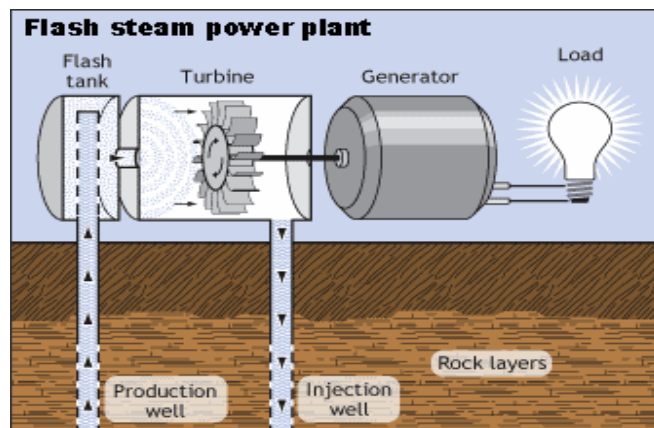

- **Flash steam plants** take high-pressure hot water from deep inside the earth and convert it to steam that drives generator turbines. When the steam cools, it condenses to water and is injected back into the ground to be used again. Most geothermal power plants are flash steam plants.

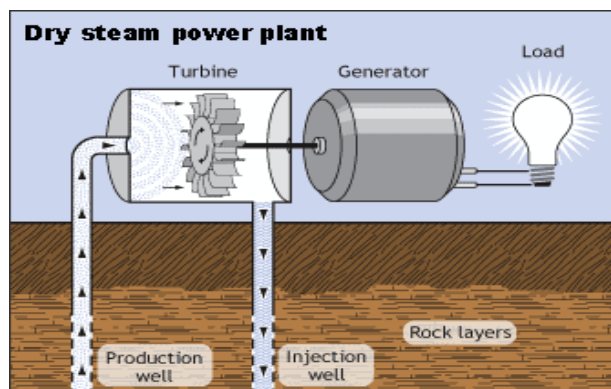

- **Binary-cycle power plants** transfer the heat from geothermal hot water to another liquid. The heat causes the second liquid to turn to steam, and the steam drives a generator turbine.

## Environment and Sustainability

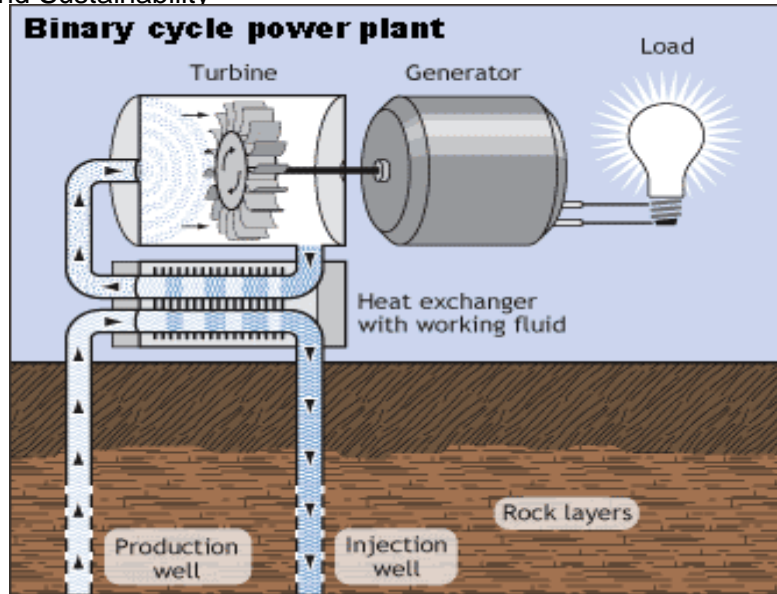
**Advantages**

1. Environmentally Friendly
2. Renewable
3. Huge Potential
4. Sustainable / Stable
5. Heating and Cooling
6. Reliable
7. No Fuel Required
8. Rapid Evolution

**Disadvantages**

1. Location Restricted
2. Environmental Side Effects
3. Earthquakes
4. High Costs.
5. Sustainability



### 1. What is energy conservation

**Energy conservation** is the effort to reduce wasteful energy consumption by using fewer energy services. This can be done by using energy more effectively (using less energy for continuous service) or changing one's behavior to use less service (for example, by driving less).

### 2. Define tidal energy

Tidal energy is a renewable source of energy that is generated from a natural source, that is, water. Therefore, it could be considered a significant part of the hydro energy generation process. The tides, so generated, due to the gravitational pull of the moon and sun over a period of time helps in the generation of tidal energy. The presence of the tidal currents contributes to moving the blades of the turbine and hence, generating electricity from the tides.

### 3. What are the concepts of geothermal energy

Geothermal energy is **heat within the earth**. The word geothermal comes from the Greek words geo (earth) and therme (heat). Geothermal energy is a renewable energy source because heat is continuously produced inside the earth. People use geothermal heat for bathing, to heat buildings, and to generate electricity.

### 4. What is the origin of geothermal energy

**The first geothermal power plant was built in 1904 in Tuscany, Italy,** where natural steam erupted from the earth. Flash steam plants take high-pressure hot water from deep inside the earth and convert it to steam that



Environment and Sustainability  
drives generator turbines

## 5. What are the advantages and disadvantages of hydrogen fuel cells

### Advantages

- High Efficiency- when utilizing co-generation, fuel cells can attain over 80% energy efficiency
- Good reliability- quality of power provided does not degrade over time.

### Disadvantages:

- Expensive to manufacture due the high cost of catalysts (platinum)
- Lack of infrastructure to support the distribution of hydrogen

## 6. Define geothermal plant

Geothermal power is electrical power generated from geothermal energy. Technologies in use include dry steam power stations, flash steam power stations and binary cycle power stations.

## 7. What are the advantages and disadvantages of ocean energy

Advantages	Disadvantages
<ul style="list-style-type: none"> <li>• Cheaper and Efficient</li> </ul>	<ul style="list-style-type: none"> <li>• Highly expensive</li> </ul>
<ul style="list-style-type: none"> <li>• Renewable</li> </ul>	<ul style="list-style-type: none"> <li>• Scalability issues</li> </ul>

## 8. What are the advantages and disadvantages of geo thermal energy

Advantages	Disadvantages
1. Environmentally Friendly	1. Location Restricted
2. Renewable	2. Environmental Side Effects



## Environment and Sustainability

### 3.11 Part B & C

1. Explain the principle and steps of energy management
2. Explain the ways to conserve energy
3. Explain the new energy sources
4. Explain the applications of hydrogen energy
5. Explain the application of ocean energy resources
6. Explain the types of geothermal plants with diagram

**Sustainability and Management****4.1 Development**

Development is a process that creates growth progress, positive change in economic, environmental and social component without damaging the resources of the environment.

**Types of development**

All development fits into one of three different categories. These are:

**1. National Development**

These are set out in the National Planning Framework 3 (2014), produced by the Scottish Government. These are developments that would make a significant contribution to Scotland's overall success or its international role.

**2. Major Development**

Some categories falling under "major development" include fish farms, offices, storage and distribution centres, housing estates (50+ houses), renewables, waste management or disposal facilities, mineral extraction sites and any other development exceeding 5000 square metres.

**3. Local Development**

This is the most common form of development and comprises of small scale developments including house extensions, conversions, small and medium housing, industrial developments and small scale renewable developments. For some of these types of developments it may not be



Environment and Sustainability necessary to apply for planning permission. This is what is known as "permitted development".

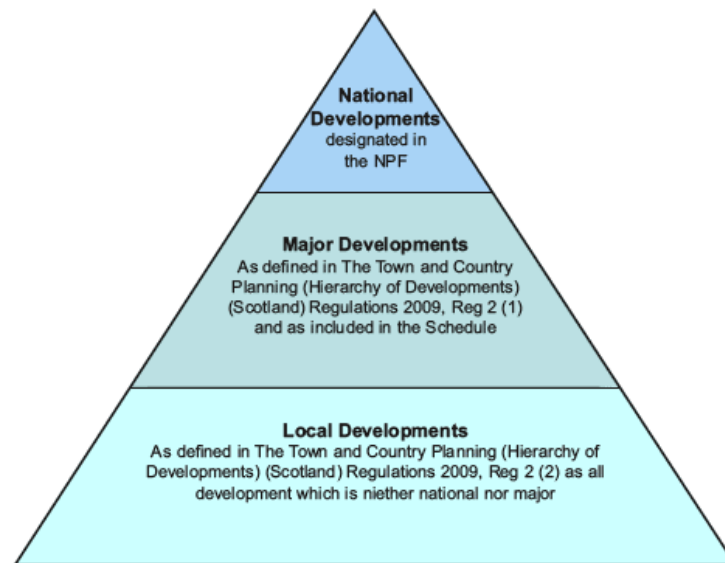

### Principles of development

- Principle 1: Equitable Use.
- Principle 2: Flexibility in Use.
- Principle 3: Simple and Intuitive Use.
- Principle 4: Perceptible Information.
- Principle 5: Tolerance for Error.
- Principle 6: Low Physical Effort.
- Principle 7: Size and Space for Approach and Use.

### Characteristics of development

1. **Development is the continuous process that takes place regularly.**
2. The growth in the process of development varies from one person to the other depending on the health, genetic characters and the food they consume



## Environment and Sustainability

3. Development follows the correct pattern in the growth as infancy to the death.

### **Importance of development**

- It helps in proper utilization of resources.
- It can be the source of employment.
- It contributes in nation development boosting economy.
- It helps in development of infrastructures.
- It helps to conserve cultural heritages.
- It helps to foster social justice and prosperity.
- Forest is one of the land areas in habitat by dense growth of trees, herbs and shrubs.

### **Steps involved in concept development**

1. Brainstorming to create a pool of potential product or service concepts.
2. Performing customer research to target your ideal customer.
3. Estimating the market potential for your product or service concept.
4. Creating a prototype for your product.
5. Devising a marketing strategy.

### **Effects of development**

Development has had many positive impacts globally. However, the environment has suffered degradation due to increased urbanisation and industrialisation. The four most significant environmental issues are deforestation, pollution, desertification, and the extinction of species



Environment and Sustainability

### **Factors affecting development.**

**Following are the important factors affecting development.**

- **Natural Resources**

(egs). Trees, soil, water, minerals, coal, oil etc.

They help countries development by creating jobs and increasing their wealth through the sales.

- **Power and energy resources**

(Egs) Oil, gas, coal and water.

They being natural, can be mined. They are important for producing power and energy within the country.

- **Capital accumulation**

If a country has more capital, it can creates more job. Low capital countries may have low living and high unemployment.

- **Technological resources**

(egs) Computers, cellphones etc.

It refers to ability to gives advance technologies within a country. It increases business, capabilities and economic development of a country. Countries with low technological resources have poor economic development.

- **Available labour force**

Number of skilled labours within the country increases the development.

- **Transportation and communication**

- **Education and training.**



Environment and Sustainability

### **Advantages of Development**

- Increased job satisfaction and morale among employees
- Increased employee motivation
- Increased efficiencies in processes resulting in financial gain.
- Increased capacity to adopt new technologies and methods.
- Economic growth increases state capacity and the supply of public goods.

### **Disadvantages of Development**

1. Population growth
2. Weak governances and rapid urbanization
3. Poverty
4. Population like smog, acid rain, green house effect, Depletion of ozone layer, sewage and garbage

### **4.2 Gross Domestic Product (GDP)**

Gross domestic product (GDP) is the total monetary or market value of all the finished goods and services produced within a country's borders in a specific time period.(12 month or a year.)

The GDP is a statistical indicator that defines the economic progress and development of a country. Percentage growth in the GDP during a quarter is considered as the standard of economic growth.

### **Types of GDP**

- **Real GDP.** Real GDP is a calculation of GDP that is adjusted for inflation. The prices of goods and services are calculated at a constant price level, which is usually set by a predetermined base year or by



## Environment and Sustainability

using the price levels of the previous year. Real GDP is considered the most accurate portrayal of a country's economy and economic growth rate.

- **Nominal GDP.** Nominal GDP is calculated with inflation. The prices of goods and services are calculated at current price levels.
- **Actual GDP.** Actual GDP is the measurement of a country's economy at the current moment in time.
- **Potential GDP.** Potential GDP is a calculation of a country's economy under ideal conditions, like a steady currency, low inflation, and full employment.

## Calculation of GDP

There are 3 different ways of calculating GDP.

1. The value added approach
2. The income approach (how much is earned or income on resource used to make stuff)
3. Expenditure approach (how much is spent on stuff of three, the expenditure approach is follow)

It is used to calculate the sum of the final uses of goods and services (all uses except intermediate consumption) measured in purchasers' prices.

$$\mathbf{GDP = C + I + G + (X - M)}$$

Where,

- **C** = consumption
- **I** = investments



#### Environment and Sustainability

- **G** = Government spending
- **X** = Exports
- **M** = Imports

#### Advantages

- Broad indicator of development
- Easy to measure growth in percentage
- Easy to compare to itself and other countries
- Cheap and easy to collect
- Calculated from a formula which all countries use, therefore it is reliable indicator.
- Good way for governments to know whether economic policies have been successful, and to what extent they have or have not been.

#### Disadvantages

- Narrow indicator that fails to show quality of life, standard of living, happiness, health care etc.
- GDP doesn't account inequality:
- Doesn't account for environmental impacts of the economic policies.
- Doesn't include the informal sector activity or the activity on the 'black' market.
- Overseas income not taken into account
- High inflation may be behind a high GDP rate

#### 4.3 Sustainability

Sustainability refers to the ability to maintain or support a process continuously over time. In business and policy contexts, sustainability seeks



Environment and Sustainability

to prevent the depletion of natural or physical resources, so that they will remain available for the long term.

#### 4.4. Need of sustainability

1. Sustainability is key to preserving our planet.
2. It helps reduce pollution and conserve resources
3. It create job and stimulates the economy.
4. It improves public health.
5. It protect biodiversity.
6. It protect the natural environment.
7. It is the choice of non toxic materials.
8. It reduces and reuses the resources.

#### 4.5 Approaches for sustainable development:

<b>1. Developing appropriate technology</b>	It uses local labour, less resources and produces minimum waste.
<b>2. Reduce, Reuse, Recycle (3-R approach)</b>	It insists optimum use of natural resources, using it again and again recycling the material into further products. It reduces waste generation and pollution.
<b>3. Providing environmental education and awareness</b>	The thinking of people towards our earth and the environment can be changed by providing environmental education and awareness
<b>4. Consumption of renewable resources</b>	The natural resources should not exceed regeneration capacity.
<b>5. Conservation of non-renewable resources</b>	Non-renewable sources should be conserved by recycling and reusing.
<b>6. Population control</b>	By controlling population growth, we can makesustainable development.



## Environment and Sustainability

### **4.6 Challenges for sustainable development:**

1. Global warming due to CO<sub>2</sub> emissions.
2. Air pollution and water contamination.
3. Pollution of the oceans, seas and inland waters.
4. Slow energy transition and insufficient share of renewable energy.
5. Uncompromising food production harms.
6. Animal species extinction and destruction of their natural habits.
7. Significant development of modern cities and agglomerations without a transparent and comprehensive urban strategy.
8. Hydric stress and water scarcity.
9. Overpopulation and waste management.

### **4.7 Economic sustainability**

Economic sustainability is the practice of conserving natural and financial resources to create long-term financial stability. A system that's sustainable can last far into the future with minimal negative impacts.

#### **(eg) a) Alternative energy**

Alternative energy sources, such as wind power, solar power and hydropower, can offer a more sustainable, clean and affordable solution to energy needs. Much of the world depends on fossil fuels like coal, oil and gasoline, which have a limited supply and create greenhouse gas emissions.

#### **a) Sustainable agriculture**

Many farms are adopting sustainable agricultural practices to reduce soil degradation, which occurs from over-farming, and to reduce animal product consumption. Reducing food consumption and focusing on



## Environment and Sustainability

regenerative farming can help improve soil health, crop yields and the quality of farmed food and resources.

### **b) Recycling and pollution reduction**

Recycling and reducing pollution is a common economic and environmental stability practice that can help increase the value of materials. For example, a company producing aluminum cans can sustain operations by recycling used cans and creating molten aluminum for recasting, instead of mining for aluminum ore.

## **4.8 Environmental Sustainability**

Our most basic requirements: unpolluted air, clean water and fresh food, all come from our environment, as does the energy and raw materials we need for construction and transportation. Environmental sustainability is essential if we wish to have and continue to have the resources to meet our needs. In the broadest sense of the definition, environmental sustainability involves the entire global ecosystem (oceans, freshwater systems, land and atmosphere). However, environmental sustainability principles can equally be applied to ecosystems of any size, even down to the scale of a small home garden.

## **4.9 Social Sustainability**

A socially sustainable society is one in which all members have equal rights, all share equitably in societal benefits, and all participate equally in the decision-making process. Additionally, a society is unsustainable if it consumes resources faster than they can be renewed naturally, discharges more waste than natural systems can assimilate without degrading, or depends

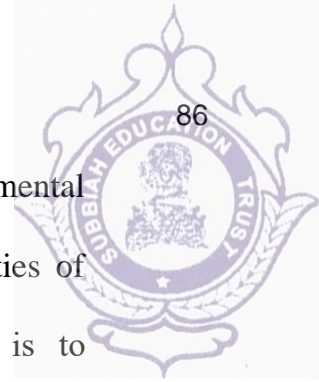

## Environment and Sustainability

upon distant sources for its most basic requirements. As with environmental sustainability, social sustainability principles can be applied to societies of any size. For example, one of sustainability's grand challenges is to simultaneously reduce consumption in the developed world while raising the standard of living of the developing world – we need to be responsible global citizens by making informed choices every day within our homes and communities.

### 4.10 Aspects of sustainability

Sustainability requires consideration of four aspects (sometimes also known as perspectives, pillars).

#### *The four aspects*

While all four aspects of sustainability are important, environmental sustainable is fundamental to the kaitiakitanga of our environment.

**Environmental** – this aspect acknowledges the need to enhance and maintain the biophysical systems that sustain all life on Earth. It includes the structure and function of natural ecosystems and the interactions between them and people, and calls for guardianship/kaitiakitanga of our environment.

**Social** – this aspect acknowledges the need for equity within and between generations, and within and between ethnic and social groups. It is inclusive of people's mental and physical well-being and the cohesion of their communities based on a fair distribution of resources.



## Environment and Sustainability

**Cultural** – this aspect acknowledges the need to nourish and share attitudes and values that represent diverse worldviews, and the political need for all people to express their views freely and to participate in decision-making. Addressing these needs can build resilience for the future.

**Economic** – this aspect acknowledges the interactions of humans with the natural environment in using resources to create goods and services which add value to their lives. It acknowledges the resource use and waste disposal must occur within the capacity of our planet. It encourages a fair trading system that equitably distributes benefits and costs. It further encourages innovation and creativity in developments that lead to a sustainable future.

### **An integrative model**

A model showing how these aspects are related (in this model, the social and cultural aspects sit within society).



Figure 1.1: Strong sustainability

There are many different models which show how these aspects are related. This model shows how our economy is a subset of our society, as in reality it is situated entirely within our society. It also shows that everything in our economy and everything in our society is situated within, and entirely

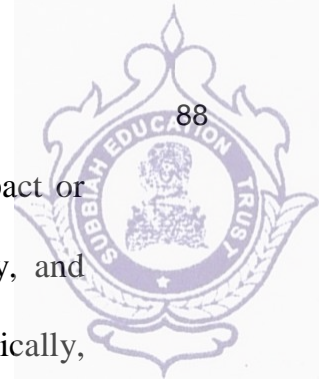

## Environment and Sustainability

dependent on, our environment. This relationship means that any impact or change to our environment will impact on society and the economy, and therefore that any sustainability-related issue must be considered holistically, and recognise this interdependence. For example, a unit on oceans as a sustainable resource might consider the marine ecosystem and how people affect it through fishing and pollution (as in science), the socio-cultural aspects of seafood harvesting (as in geography), and the economic impact of fishing and tourism (economics).

### **4.11 From unsustainability to sustainability**

Our ancestors have left a lot of resources for us. They used their resources sensibly and not for their greed. But we are exploiting limited resources. Instead of using it for our needs, we are exploiting it for our greed.

#### **Characteristics of unsustainability**

1. Unsustainability is one in which we longer responsibility towards the environment.
2. In unsuitability, we degrade the valuable resources.
3. It not at all cares about the needs of future generations.
4. Unsystematic planning can lead to damage in social as well as human made resources.
5. It leads to extreme degradation of the environment as well as living organism.



## Environment and Sustainability

### Causes of unsustainability

- Inappropriate Incentives.
- High Demand for Limited Resources.
- Complexity and Lack of Knowledge.
- Poverty and Lack of Alternatives.
- Lack of Effective Governance.
- Externalities.

### Characteristics of sustainability

- Saved lives.
- Reduced damage to property.
- Reduced economic losses.
- Minimized social disruption.
- Ability of local government to resume operations quickly.
- Shorter recovery period for the community.
- Improved attractiveness to individuals and businesses by demonstrating effectiveness in dealing with a disaster.

### *What Are the Differences Between Sustainable and Unsustainable?*

	What is <b>sustainable</b> ?	What is <b>unsustainable</b> ?
<b>Environmental</b> sustainability	Preservation of natural resources	Exploitation of resources faster than the planet can handle and replenish
<b>Economic</b> sustainability	Long-term economic growth without negatively	Not quantifying ecosystem services at and increased

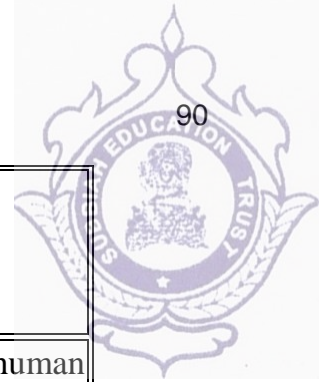

Environment and Sustainability

	impacting our environment or society	vulnerability to crises
<b>Social</b> sustainability	Equality, diversity, social cohesion, and democracy	Racism, labor laws, human rights, gender inequality, and poor treatment of indigenous peoples

**4.12 Millennium Development Goals (MDGs)**

*Sustainable Protocols*

1. Eradicate Extreme Poverty and Hunger
2. Achieve Universal Primary Education
3. Promote Gender Equality and Empower Women
4. To Reduce child mortality
5. Improve Maternal Health
6. Combat HIV/AIDS, Malaria and other Diseases
7. Ensure Environmental Sustainability
8. Develop a Global Partnership for Development

Sustainability standards play a central role in global trade, and greatly contribute to the improvement of environmental and social compliance in supply chains. They represent guidelines used by producers, manufacturers, traders, retailers, and service providers to develop good environmental, social, ethical, and food safety practices. If you want to know more about what standards are, the different types that exist, how firms can approach voluntary sustainability standards, how to get your business certified and the main



## Environment and Sustainability

potential advantages and disadvantages linked to certification, you cannot miss these materials made by the International Trade Centre (ITC).

### 4.13 Sustainability protocols:

- LEED
- WELL
- Fitwel
- Living Building Challenge
- BREAM
- Passive House
- National Green Building Standard
- The principles
- History of SD

### 4.14 Sustainable development

"Sustainable development is development that meets the needs of the present, without compromising the ability of future generations to meet their own needs."

#### Key aspects for sustainable development:

##### 1) Inter – generational equity:

- We should minimize any adverse impacts on resources and environment for future generations
- We should handover a safe, healthy, and resourceful environment to our future generations



## Environment and Sustainability

- This is possible only if we stop over exploitation of resources, reduce waste discharge and emissions and maintain ecological balance

### **2 Intra – generational equity:**

- The development process should seek to minimize the wealth gaps within and between nations
- The technology should address to the problems of developing countries, producing drought tolerant varieties for uncertain climates, vaccines for infectious diseases, clean fuel for domestic and industrial use
- This will support the economic growth of poor countries, narrowing the wealth gap and lead to sustainability

### **4.15 Sustainable development goals (SDGs)**

1. End poverty in all its forms everywhere
2. End hunger, achieve food security and improved nutrition and promote sustainable agriculture.
3. Ensure healthy lives and promote well-being for all at all ages.
4. Ensure inclusive and equitable quality education and promote lifelong learning opportunities for all.
5. Achieve gender equality and empower all women and girls.
6. Ensure availability and sustainable management of water and sanitation for all.
7. Ensure access to affordable, reliable, sustainable and modern energy for all.



## Environment and Sustainability

8. Promote sustained, inclusive and sustainable economic growth, full and protective employment and decent work for all.
9. Build resilient infrastructure, promote inclusive and sustainable industrialization and foster innovation.
10. Reduce inequality within and among countries.
11. Make cities and human settlements inclusive, safe, resilient and sustainable.
12. Ensure sustainable consumption and production patterns
13. Take urgent action to combat climate change and its impact.
14. Conserve and sustainably use the ocean, seas and marine resources for sustainable development.
15. Protect, restore and promote sustainable use of terrestrial ecosystems, sustainably manage forests, combat desertification, halt and reverse land degradation and halt biodiversity loss.
16. Promote peaceful and inclusive societies for sustainable development, provide access to justice for all and build effective, accountable and inclusive institutions at all levels.
17. Strengthen the means of implementation and revitalize the global partnership for sustainable development.

### **4.16 Intervention areas of sustainable development goals**

- Climate change
- Use of natural resources
- Water pollution
- Water production



#### Environment and Sustainability

- Deforestation
- Poverty
- Ocean acidification
- Air pollution

#### 4.17 Climate change

Climate is **the average weather of an area.**

##### Reasons for climate change (Causes)

- i) Presence of green house gases.
- ii) Depletion of ozone layer.
- iii) Volcanic eruptions
- iv) Global Warming

##### Effects of climate change

- i) Even small change in climate conditions may disturb agricultural activities
- ii) Migration of animals as well as human beings.
- iii) Climate change may affect the hydrological cycle results in floods, drought.
- iv) Wind and Ocean currents also get disturbed by climate

#### 4.18 CASE STUDIES

##### Damage to coral reefs, Pacific

The severity of periodic warming due to El Nino in 1997 in the Pacific led to the most serious death in coral ever known. It is estimated that about 10% of the Earth's coral reefs were dead, another 30 % were seriously affected and another 30% were de-graded. The Global Coral Reef Monitoring



## Environment and Sustainability

Network Townsville, Australia, has predicted that all the reefs could be dead by 2050.

### **Butterfly populations in the United Kingdom**

Global warming is leading to an early arrival of butterflies in Britain. Scientists say that butterflies can now be spotted much earlier every year in the last two decades. Some, like the red admiral, can now be seen a month earlier than was the case in the mid – 1970s. Others, like the peacock and the orange tip are appearing between 15 and 25 days earlier than in the past. Future rise in temperature is likely to have a detrimental effect on these butterflies. Some butterflies which need cooler temperatures might suffer.

### **Sembakkam Lake in Chennai**

Sembakkam Lake, on the outskirts of the Indian city of Chennai, offers a placid view on a recent afternoon, with migratory birds cruising its shores and a small boat with two fishermen bobbing in the center. The calm belies the lake's pioneering role in a struggle against climate change, and the toll rising sea levels will exact on this rapidly expanding city of 8 million people.

### **4.19 Carbon credit**

A carbon credit (often called a carbon offset) is **a credit for greenhouse emissions reduced or removed from the atmosphere by an emission reduction project**, which can be used by governments, industry, or private individuals to compensate for the emissions they generate elsewhere.

#### ***Types***



## Environment and Sustainability

There are two types of credits. Voluntary emissions reduction (VER) is a carbon offset that is exchanged in the over-the-counter or voluntary market for credits. Certified emissions reduction (CER) relies on emission units (or credits) created through a regulatory framework with the purpose of offsetting a project's emissions.

### **Advantages**

Carbon credits, purchased voluntarily, **enable organizations to compensate for or neutralize emissions that have not yet been eliminated**, by financing projects that reduce or avoid emissions from other sources, or that remove greenhouse gases from the atmosphere.

### ***Disadvantages of Carbon Credit***

The main disadvantage of the carbon credit is precisely in this exchange market. Some institutions and countries can accommodate themselves in this market to continue emitting their greenhouse gases. They do not invest in actions to avoid emissions because they are able to buy unlimited credits.

In this case, the reduction of 1 ton of carbon, that is, 1 credit, will never be enough. Because, in fact, somebody will use this ton, so there won't really be an emission reduction. It is a disadvantage that causes much controversy among environmentalists and world leaders.

The use of carbon credit also needs to be thought of in a sustainable way. Understand that it is an alternative for emergency needs, not to rest on the fact that the other has saved.



## Environment and Sustainability

Everyone's focus must be on reducing greenhouse gas emissions. Only in this way will it be possible to stop the negative impacts caused by global warming.

### 4.20 Carbon Footprint

It is the total amount of greenhouse gases (including CO<sub>2</sub> and CH<sub>4</sub>) that are generated by our direct or indirect activities.

#### Sources

- i) Climate change
- ii) Natural process like volcanos
- iii) Greenhouse gas emitted from human activities
- iv) Pollution
- v) Transportation
- vi) Electricity generation
- vii) Industrial activities

#### How to lower carbon footprint

- ❖ Calculate your carbon footprint
- ❖ Drive less
- ❖ Switch to an electric or hybrid car
- ❖ Travel smart
- ❖ Switch to renewable energy
- ❖ Consider solar panels
- ❖ Unplug electrical devices when not in use
- ❖ Get energy efficient appliances
- ❖ Don't waste water



Environment and Sustainability

- ❖ Reduce, reuse and recycle

#### **4.21 Environmental management**

Environmental management is the process of allocating natural and man-made resources so as to make optimum use of the environment in satisfying not only the present basic human needs but of the coming generations also.

##### **Objectives**

1. To prevent and solve environmental problems;
2. To establish limits;
3. To develop research institutions and monitoring systems;
4. To warn threats and identify opportunities;
5. To suggest measures for resource conservation;
6. To develop a strategy for the improvement of quality of life;
7. To suggest long-term and short-term policies for sustainable development;
8. To identify new technology for sustainable development.

##### **Characteristics**

1. It deals with a world affected by humans;
2. It supports sustainable development;
3. It demands a multidisciplinary approach;



## Environment and Sustainability

4. It has to integrate different development viewpoints;
5. It concerns with short-term and long-term planning as well as from local to global scale;
6. It seeks to integrate natural and social science, policy making and planning.

### **The Principles of Environmental Management:**

These are some guiding principles of environmental management. These principles are helpful in environmental decision making.

#### ***1. Polluter Pays Principle (PPP):***

For the last two decades, many economists have suggested that firms discharging polluting effluents to the environment should somehow be made to pay a price for such discharges related to the amount of environmental damage caused.

OECD has suggested the Polluter Pays principles (PPP) as a general basis for the environmental policy. It states that if measures are adopted to reduce pollution, the costs should be borne by the polluters. According to the OECD Council, “The principle to be used for allocating costs of pollution prevention and control measures to encourage rational use of scarce environmental resources and to avoid distortions in international trade and investment is the so-called Polluter Pays Principle.” The essential concern of this principle is that polluters should bear the costs of abatement without subsidy.



## Environment and Sustainability

The Polluter Pays Principle, as interpreted by the Supreme Court of India, means that the absolute liability for harm to the environment extends not only to compensate the victims of pollution but also the cost of restoring the environmental degradation. Thus, it includes environmental costs as well as direct costs to people or property. Remediation of the damaged environment is part of the process of sustainable development and as such the polluter is liable to pay the cost to the individual sufferers as well as the costs of reversing the damaged ecology.

The application of this principle depends upon the interpretations, particular cases and situations. This principle has brought more controversial discussions during the Rio Earth Summit 1992. The South has demanded more financial assistance from the North in combating the environmental degradation in the South.

There are practical implications on the allocation of economic obligations in relation to environmentally damaging activities, particularly in relation to liability and the use of economic instruments.

### ***2. The User Pays Principle (UPP):***

It is considered as a part of the PPP. The principle states that all resource users should pay for the full long-run marginal cost of the use of a resource and related services, including any associated treatment costs. It is applied when resources are being used and consumed.



Environment and Sustainability

### ***3. The Precautionary Principle (PP):***

The main objective of the precautionary principle is to ensure that a substance or activity posing a threat to the environment is prevented from adversely affecting the environment, even if there is no conclusive scientific proof of linking that particular substance or activity to environmental damage. The words 'substance' and 'activity' are the result of human intervention.

The Rio Declaration in its Principle 15 emphasizes on this principle, wherein it is provided that where there are threats of serious or irreversible damage. Lack of full scientific certainty shall not be used as a reason for postponing cost effective measures to prevent environmental degradation. Therefore, the principle is essential for the protection of environment and human health by implementing in the field of production and distribution of energy resources.

### ***4. Principle of Effectiveness and Efficiency:***

It is essential that efficiency of resources use may also be accomplished by the use of policy instruments that create incentive to minimize wasteful use. It also applies to various issues of environmental governance by streamlining processes and procedures in order to minimize environmental costs.

### ***5. The Principle of Responsibility:***

It is the responsibility of all persons, corporations and states to maintain the ecological processes. Further, access to environmental resources



Environment and Sustainability

carries attendant responsibilities to use them in an ecological sustainable economically efficient and socially fair manner.

### ***6. The Principle of Participation:***

It is the duty of all the persons to participate in collectively environmental decision making activities. Some participation areas are related to the use of trees and other plants, minerals, soils, fish and wildlife for purposes such as materials and food as well as for consumptive and non-consumptive recreation. The second issue concerns solid waste i.e. garbage, construction and demolition materials and chemically hazardous waste etc. The third issue of participation is related to pollution generating activities.

### ***7. The Principle of Proportionality:***

The principle of proportionality is based on the concept of balance. A balance is to maintain between the economic development on the one hand and environmental protection on the other hand. It cannot be disputed that no development is possible without some adverse effects on ecology. Therefore, it is essential to adjust the interest of the people as well as the necessity to maintain the environment. Moreover, comparative hardships have to be balanced and benefits to a larger section of the people have to be maintained.

### **Steps involved in environmental management**

- **Environmental Policy**

The EMS development process starts with establishing an Environmental Policy that is tied to the organization's mission.



## Environment and Sustainability

- **Planning**

The planning step consists of identifying regulatory and other requirements; identifying processes, resources, and significant impacts; identifying pollution prevention opportunities; developing objectives and targets for improvement efforts; and creating a planning, programming, and budgeting system.

- **Implementation**

The implementation step consists of defining the structure, responsibilities, and programs; implementing training; creating the EMS documentation (including document control and record keeping); communicating the EMS to personnel; developing and implementing standard operating procedures [SOPs]; and developing and implementing emergency preparedness and response procedures.

- **Checking and Correction**

The checking and corrective action step includes monitoring and measuring (e.g., internal assessments), problem and cause identification, corrective and preventative action implementation, and an EMS Review.

- **Management Review**

In the management review step, upper management reviews the EMS, including the results of internal assessments. Modifications to the EMS are made, as necessary, to ensure compliance. The management review is designed to ensure continual improvement of the EMS, taking into account the results of checking and corrective actions undertaken in Step 4.



## Environment and Sustainability

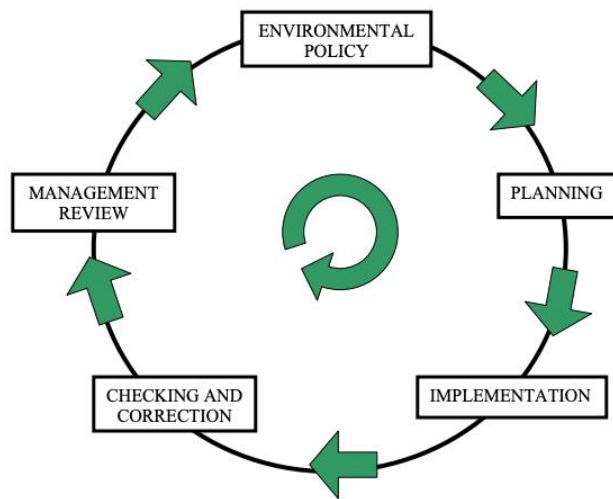

### Benefits

- Improved environmental performance.
- Enhanced compliance.
- Pollution prevention.
- Resource conservation.
- New customers/markets.
- Increased efficiency/reduced costs.
- Enhanced employee morale.
- Enhanced image with public, regulators, lenders, investors.

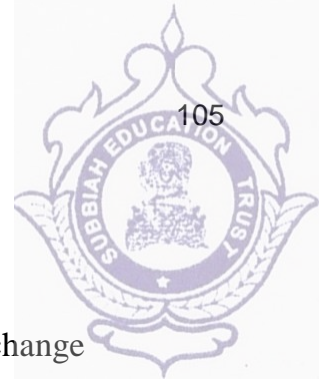

Environment and Sustainability  
**4.22 Part A**

**1. What is your development**

Development is a process that creates growth progress, positive change in economic, environmental and social component without damaging the resources of the environment.

**4 What is GDP**

Gross domestic product (GDP) is the total monetary or market value of all the finished goods and services produced within a country's borders in a specific time period.(12 month or a year.)

**5 What are the advantages of GDP**

- Broad indicator of development
- Easy to measure growth in percentage
- Easy to compare to itself and other countries
- Cheap and easy to collect

**6 Define sustainability**

Sustainability refers to the ability to maintain or support a process continuously over time. In business and policy contexts, sustainability seeks to prevent the depletion of natural or physical resources, so that they will remain available for the long term.

**7 Define sustainable development**

"Sustainable development is development that meets the needs of the present, without compromising the ability of future generations to meet their own needs."



Environment and Sustainability

## **8 Write millennium development goals**

1. Eradicate Extreme Poverty and Hunger
2. Achieve Universal Primary Education
3. Promote Gender Equality and Empower Women
4. To Reduce child mortality
5. Improve Maternal Health

## **9 Define carbon credit**

A carbon credit (often called a carbon offset) is a credit for greenhouse emissions reduced or removed from the atmosphere by an emission reduction project, which can be used by governments, industry, or private individuals to compensate for the emissions they generate elsewhere.

## **10 What is carbon footprint. How is it prevented**

It is the total amount of greenhouse gases (including CO<sub>2</sub> and CH<sub>4</sub>) that are generated by our direct or indirect activities.

### **Prevention**

- ❖ Calculate your carbon footprint
- ❖ Drive less
- ❖ Switch to an electric or hybrid car
- ❖ Travel smart



Environment and Sustainability  
**4.23 Part B & C**

1. Explain the need approaches and aspects of sustainability
2. Write a short note on and sustainability to sustainability
3. Write a short note on climate change
4. Explain sustainable development with goal targets and indicators
5. Write a short note on carbon credit
6. Write a short note on environmental management

**Sustainability Practices****5.1 Zero Waste**

**Zero waste** is a set of principles focused on waste prevention that encourages redesigning resource life

**Objectives of Waste Management**

The primary goal of solid waste management is reducing and eliminating adverse impacts of waste materials on human health and the environment to support economic development and superior quality of life cycles so that all products are reused.

**Concept of zero waste**

The conservation of all the resources by means of possible production, consumption, reuse and recovery of products, packaging and material without burning and with a discharges to land, water or air that threaten the environment or human health.

**Examples.**

The major components are **food waste, paper, plastic, rags, metal and glass**, although demolition and construction debris is often included in collected waste, as are small quantities of hazardous waste, such as electric light bulbs, batteries, automotive parts and discarded medicines and chemicals.

**Principles of zero waste**

**Refuse, Reduce, Reuse, Recycle, Rot** – these are the “5 Rs” that make up the basic rules of zero waste. These rules were proposed by Béa Johnson in



Environment and Sustainability

her book “Zero waste home: the ultimate guide to simplifying your life by reducing your waste”



### 5.2.5 R's in zero waste management

The 5 R's provide a new scheme for dealing with waste in our lives by helping us focus on our habits and consumption patterns.

#### 1. Refuse: refuse what you don't need

The first step to a zero-waste lifestyle is to **prevent** the waste from entering your home in the first place. This involves saying “no” to promotional samples, junk mail, single-use disposables such as bags, straws, cups, and cutlery, or any short-lived form of unnecessary items.

#### 2. Reduce what you do need

Reducing what you do need implies getting clear about **what you need** and being **mindful** about your purchasing decisions. It means to let go of household items that are no longer of use and avoid impulse purchases such as buy 1-get-2 offers, discount products, and processed foods among others.

Reducing not only results in saving more money from expending less but also



## Environment and Sustainability

saving time and becoming more efficient by alleviating physical and mental clutter.

### 3. Reuse, extend the useful life of the product

Reusing involves **repairing** instead of throwing and replacing products and **switching single-use items by permanent alternatives**. This includes replacing plastic bottles with stainless steel water bottles, for instance, using fabric bags, bamboo toothbrushes, or buying unpackaged foods among other solutions. Also buying second-hand and visiting antique stores.

### 4. Recycle what you cannot refuse, reduce or reuse

Recycling comes as the last option after refusing, reduce and reusing. The reason is, nowadays, **we consume and dispose at a higher path than we are capable of recycling**. As a result, many recyclable materials end up in landfills, shipped to developing countries, or in WTE incineration plants as they couldn't be recycled.

### 5. Rot what is left

Rot or **transform** what is left. This applies mainly to **organic waste** coming from food. As a consumer, there are some methods to compost your household waste such as the Bokashi method, garden compost, or vermicomposting. On the other hand, WTE systems like REVALUO, transform municipal organic waste into fuel.

### Advantages

- It is cost-effective.
- It produces less plastic waste and pollution.
- It also reduces food waste.



### Environment and Sustainability

- It promotes a healthier lifestyle.
- It reduces our interactions with toxic chemicals.
- It promotes a circular economy.
- It will help you change your shopping habits.
- It reduces global warming.
- It requires self-discipline.

### Disadvantages

- It can be stressful and overwhelming for large families and businesses.
- It can get expensive.
- It is time-consuming.
- Some products do not have a zero-waste alternative.
- There are limited zero-waste stores.

### 5.3 Circular economy

A circular economy strives for the longest possible use of products and raw materials. In practical terms, this means avoiding waste through reuse or further use (recycling / reuse). If that is not possible, they are broken down into their starting materials, i.e. raw materials, and these are recycled. Waste avoidance and reuse always come before recycling.

#### *What are our goals?*

- To help you understand the full set of **risks** and **opportunities** that a transition to the circular economy will pose to your business
- To help you develop **targets** and **strategies** that not enable your business to capitalise on these circular opportunities, while concurrently mitigating the associated risks



## Environment and Sustainability

- To help you to **imagine** and then **prototype** new products, new businesses models, and broader innovations that allow you to transition to a more circular business
- Build ‘unusual’ yet powerful **coalitions** to conceive, develop, implement and scale-up the transformative solutions and interventions we need to reconfigure systems towards circularity

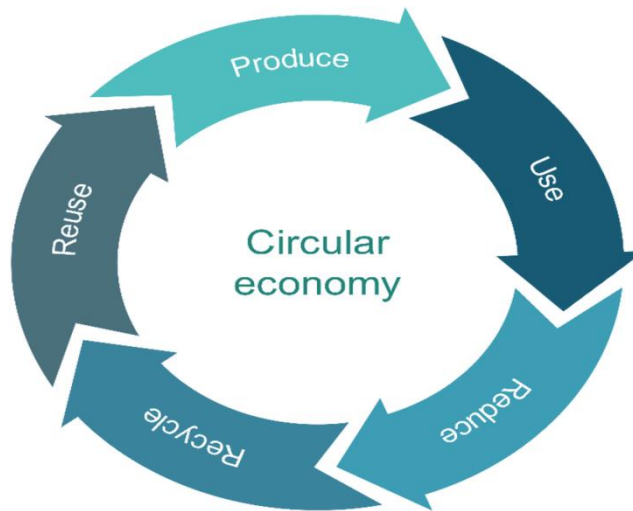

### Benefits of circular economy

- Reduces the use of non-renewable resources.
- Lowers carbon emissions.
- Aims for zero waste.
- Provides benefits for the consumer.
- Opens new opportunities for companies.

### Steps to achieve circular economy

#### 1. Refuse

We consume more than we need. Every year, we increase the goods we own by 25 billion tonnes – the equivalent of 93,000 Empire State Buildings. Much of this sits idle – cars lay dormant 92% of the time while offices are

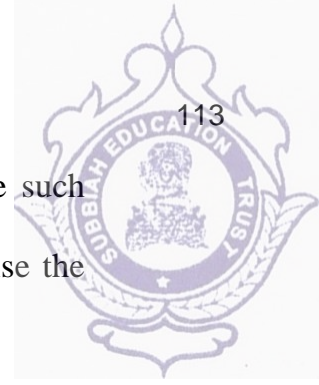

## Environment and Sustainability

vacant for 58% of the year. We can change this by refusing to have such unnecessary and unsustainable products through solutions that maximise the usage of fewer goods.

### **2. Rethink**

Every product and every system needs to be rethought with a focus on how to reduce its environmental impact. And the investment community is moving to help. SVB Financial Group, the holding company for Silicon Valley Bank, funds innovative startups and venture capitals working towards sustainable goals in industries such as mobility, finance, manufacturing and healthcare. By investing in innovative projects and supporting rethinkers, we can move faster to an eco-driven society. By investing in innovative projects and supporting rethinkers, we can move faster to an eco-driven society

### **3. Reduce**

The central idea of a circular economy is dematerialisation or “doing more with less”. To achieve this we need to use and manufacture products in smarter ways. Amongst many others, we have seen opportunities in carbon fibres, bio-plastics, bio-based chemicals, low-impact steel and aluminium processes that could benefit a range of industries. US company Eastman Chemicals, for example, offers smart solutions for everyday products. Last year, it began commercial-scale recycling for a range of waste plastics that would otherwise be put in landfill.



## Environment and Sustainability

### **4. Reuse**

To achieve zero-waste and reduce carbon emissions, we must look beyond the take-make-waste extractive industrial model. One area of concern is fast fashion, which is getting faster – consumers buy 60% more clothes than in 2000, but keep each garment half as long. However, consumers are also becoming more sustainability-conscious and the sharing economy is rising. Online marketplace Vinted is an example of this shift. Vinted offers a peer-to-peer service where users buy, sell and swap secondhand clothing. Now in 12 countries, the platform has passed a valuation of \$1 billion, making it Lithuania's first tech unicorn. One area of concern is fast fashion, which is getting faster – consumers buy 60% more clothes than in 2000, but keep each garment half as long

### **5. Repair**

Planned obsolescence and a throwaway culture is a grim reality of today's society. Every year some 50 million tonnes of e-waste is discarded – heavier than all of the commercial airliners ever made. Against this, the “right to repair” movement is growing, demanding affordable repair solutions and better product manufacture. In October 2019, the EU adopted an eco-design law which means manufacturers of phones, tablets and laptops will be obliged to make their products easier to repair.

One company is leading by example. French Groupe SEB, a leading small appliances manufacturer, has made repairability one of the pillars of its sustainable development policy. It aims to extend product life cycles and to



Environment and Sustainability  
preserve rather than throw away.

## **6. Refurbish**

Refurbishing is the process of restoring an old or discarded product and bringing it up to date to serve its initial function. Damaged components are replaced resulting in an overall update while the product looks brand new. Enhancing the refurbishment of products can decrease the need for new materials, resulting in a reduction of waste and carbon emissions. Two platforms specialized in e-waste, offer solutions: the French Back Market and the Austrian Refurbed.

## **7. Remanufacture**

Remanufacture, or reconditioning, involves refurbishing and re-using parts of a discarded product in a new product with the same function. Amongst the many areas in which items are remanufactured are aircraft components, engines, components, office furniture and medical equipment. Canon, for instance, has been remanufacturing devices with more than one function since 1992, echoing its ethos to maximise resource efficiency.

## **8. Repurpose**

What if an old ladder could be turned into a brand new bookshelf? Upcycling – repurposing a discarded product into a new one with a different function – is a growing trend. And the fashion industry is leading the way. Swiss brand Freitag transforms used truck tarps into highly functional, iconic bags. Airline Lufthansa has launched its Lufthansa Upcycling

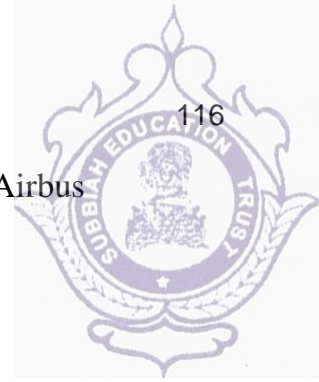

## Environment and Sustainability

Collection, working with renowned designers to upcycle parts of its Airbus A340-600 D-AIHO into a home and accessories collection.

### **9. Recycle**

Today, only 9% of our used materials are recycled. Could we increase this number for less than it would cost to source the equivalent virgin materials? As public opinion moves increasingly against single use plastics, companies are looking to capitalise. For instance, in Australia, the cellulose used to bind roads together is made from paper, plastic and lids that were meant for landfill. And the UK has recently seen the launch of Loop, an online shopping service which delivers products in reusable packaging. Today, only 9% of our used materials are recycled

### **10. Recover**

What if waste wasn't? Through anaerobic digestion, microorganisms can break down biodegradable waste into materials we can use to generate energy, as well as reduce pollution, water acidification and carbon emissions. Europe is a leader in the practice, with the biggest biomethane plant located in the Valdemingómez technological park in Madrid. While there are many benefits to this process, it is vital to ensure that bio-waste is sustainably sourced and is the last resort after all other "10R" options of the circular economy have been exhausted.

### **5.4 ISO 14000 STANDARDS SERIES**

ISO 14000 is defined as a series of international environmental management standards, guides, and technical reports. The standards specify



Environment and Sustainability requirements for establishing an environmental management policy, determining environmental impacts of products or services, planning environmental objectives, implementing programs to meet objectives, and conducting corrective action and management review.

### **Objectives of ISO 14000 STANDARDS SERIES**

The primary objective of the ISO 14000 series of standards is to promote effective environmental management systems in organizations. The standards seek to provide cost-effective tools that make use of best practices for organizing and applying information about environmental management.

### **List of ISO 14000 STANDARDS SERIES**

The ISO 14000 family was developed in response to a recognized industry need for standardization. With different organizational approaches to environmental management, comparisons of systems and collaboration had proved difficult.

- ISO 14000 standards and practices can be applied to any organization, regardless of size or industry.

### **ISO 14000 history**

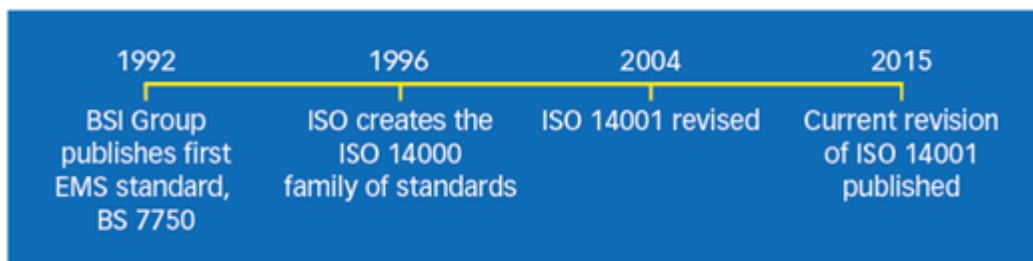

### **History of ISO 14000**

- The first environmental management system standard, BS 7750, was published in 1992 by the BSI group.



## Environment and Sustainability

- In 1996, the International Organization for Standardization (ISO) created the ISO 14000 family of standards.
- ISO 14001 underwent revision in 2004.
- The current revision of ISO 14001 was published in September 2015.

### **Advantages**

- Less extraction of virgin raw materials.
- Reduced consumption of **fossil fuels**.
- Extending the useful life of products through actions such as recycling.
- Decrease in waste generation.
- Innovation and economic growth.
- Allows for a change in consumption habits.
- Greater independence in terms of imports and agility in supply.
- Creation of new jobs.

### **Disadvantages**

- Lack of regulations governing legal competition among companies.
- Lack of environmental awareness on the part of suppliers and clients.
- Economic barriers and access to financing.
- Technical skills and abilities that are not yet present in the workforce.
- Presence of waste that is difficult to recycle and transform.
- Consumer acceptance problems.

## **5.5 Life Cycle Assessment**

A Life Cycle Assessment (LCA) is an analysis of the impact one object has on the world around it. In this guide, you get an in-depth, non-technical overview of:



## Environment and Sustainability

- What a Life Cycle Assessment really is,
- The different approaches to it,
- How it works in practice,
- And who can benefit from it.

### Benefits

- process and product-design improvement
- marketing (e.g., backing up environmental claims or meeting consumer demand for green products)
- hot-spot analysis to facilitate continuous improvement
- third-party verification or certification
- method for quantifying key environmental impacts (e.g., greenhouse gas, carbon emissions, water use, and energy consumption)
- goal-setting for climate-change and other sustainability policies

### The 5 Steps of a Product Life Cycle (Cradle to Grave)

1. Raw Material Extraction
2. Manufacturing & Processing
3. Transportation
4. Usage & Retail
5. Waste Disposal





## Environment and Sustainability

	<b>LCA Metrics</b>	<b>Economic Value Metrics</b>
<b>Advantages</b>	<ul style="list-style-type: none"> <li>• Detailed and Flexible</li> <li>• Directly accounts for environmental impacts including scarcity and toxicity</li> </ul>	<ul style="list-style-type: none"> <li>• Uses readily available data which is frequently updated</li> <li>• Easy to calculate</li> <li>• Easily comprehensible</li> </ul>
<b>Disadvantages</b>	<ul style="list-style-type: none"> <li>• Expensive</li> <li>• Requires value judgment on environmental priorities</li> <li>• Requires extensive detailed knowledge to conduct and interpret</li> </ul>	<ul style="list-style-type: none"> <li>• Does not directly incorporate environmental data</li> <li>• Policies do not influence all material metrics evenly</li> </ul>

## 5.6 ENVIRONMENTAL IMPACT ASSESSMENT

It is a process of evaluating the likely environmental impacts of a proposed project or development, taking into account inter-related socio-economic, cultural, and human-health impacts, both beneficial and adverse. EIA is a tool used to assess the positive and negative environmental, economic, and social impacts of a project. This is used to predict the environmental impacts of a project in the pre-planning stage itself so that decisions can be taken to reduce the adverse impacts.

### Evolution & History of EIA

EIA is termed as one of the best policy innovations in the 1900s. The main aim of EIA is to conserve the environment and bring out the best combination of economic and environmental costs and benefits. Read the below-mentioned points to understand the Environmental Impact Assessment evolution and history:

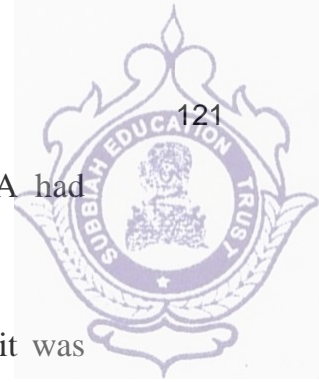

## Environment and Sustainability

1. The birth of EIA is dated back to the 1970s. In 1969, The USA had brought its first National Environment Policy Act (NEPA) 1969.
2. The EIA was initially practised by developed nations but slowly it was also introduced in developing nations including India.
3. Columbia and the Philippines are the earliest examples of developing nations who introduced EIA in their policies. Columbia brought it in 1974 while the Philippines in 1978.
4. Worldwide, EIA is now practised in more than 100 countries. By the mid-1990s, some 110 countries applied EIA as a major environmental policy.
5. In 1989, EIA was adopted as the major development project by the World Bank.

## **Objectives of Environmental Impact Assessment**

1. Identifying, predicting, and evaluating economic, environmental, and social impacts of development activities.
2. Providing information on the environmental consequences for decision making.
3. Promoting environmentally sound and suitable development by identifying appropriate alternatives and mitigation measures.

## **Importance of Environmental Impact Assessment**

1. EIA is a good tool for prudent environment management.
2. It is government-policy that any industrial project in India has to secure EIA clearance from the Environment Ministry before approval for the project itself.



**Environmental Impact Assessment (EIA) Process**

The table below will mention the EIA Process in brief:

Environmental Impact Assessment (EIA) Process	
Process	Details in Brief
Screening	Which projects need a full or partial assessment study is decided in this stage
Scoping	<ul style="list-style-type: none"> <li>• Which impacts are necessary to be assessed is decided in this stage. While doing so, legal requirements, international conventions, expert knowledge, and public engagement are also considered.</li> <li>• Alternative solutions that avoid or at least reduce the adverse impacts of the project are also studied in this stage</li> <li>• Investigation of alternate designs or sites that avoid or mitigate impact takes place</li> </ul>
Assessment & Evaluation of Impacts and Development of Alternatives	Environmental impacts of the proposed project are analyzed and light is thrown upon the alternatives present to such projects
EIA Report also called Environmental Impact Statement (EIS)	An environmental management plan (EMP) and also a non-technical summary of the project’s impact is prepared for the general public in this stage
Decision Making	The fate of the project is decided. Whether the project is to be given approval or not and if it is to be given, under what conditions
Monitoring,	Monitoring whether the predicted impacts and the

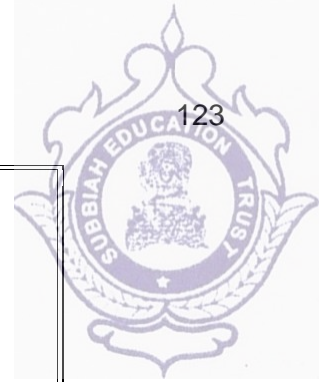

## Environment and Sustainability

compliance, enforcement and environmental auditing	mitigation efforts happen as per the EMP
--	--

### 5.7 Sustainable habitat

A sustainable habitat is achieving stability between the economic and social development of human habitats together with the defense of the environment, shelter, basic services, social infrastructure, and transportation.

A sustainable habitat is required to make sure that one species' waste ends up being the energy or food source for another species. It involves the preservation of the ecological balance in terms of a symbiotic perspective on urban development while developing urban extensions of existing towns.<sup>[1]</sup>

The term often refers to sustainable human habitats, which typically involves some form of green building or environmental planning.

#### Features of sustainable habitat are:

1. Proper waste management
2. Affordable housing
3. Wastewater treatment and facility of recycling wastewater
4. Green transportation using green fuel like biodiesel.

### 5.8 GREEN BUILDING

**A green or sustainable building is a building that, because of its construction and features, can maintain or improve the quality of life of the environment in which it is located.** To do this, it is essential to achieve a high level of efficiency: reducing the consumption of energy, water and other

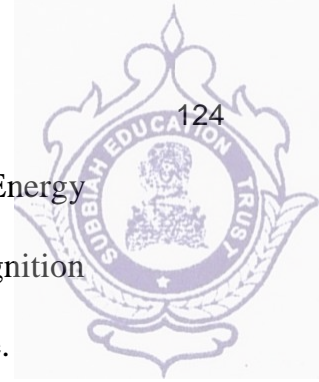

## Environment and Sustainability

resources minimises pollution. The LEED certificate (Leadership in Energy and Environmental Design) is the internationally accepted official recognition that establishes whether a building deserves to be considered sustainable.

## **CHARACTERISTICS OF GREEN BUILDINGS**

To evaluate a building's sustainability, LEED certification establishes a points system based on various sections, which we will review below, related to design and construction:

### **Location and transport**

Do not build in environmentally sensitive locations and provide public transport to reduce private car use.

### **Sustainable sites**

Protect and maintain the natural habitat, reduce pollution and the use of natural resources and facilitate interaction with nature.

### **Principles**

- sustainable design
- durability
- energy efficiency
- waste reduction
- indoor air quality
- water conservation
- sustainable building materials



## Environment and Sustainability Components

### 1. Aluminum Weather Resistant Insulated Access Panel

Aluminum panels help regulate indoor temperature and prevent moisture and pests from entering. It is essential to use an aluminum weather-resistant insulated access panel to create a tight seal that will keep the inside of your building comfortable and dry.

### 2. Energy Efficient Windows

Windows are one of the most significant sources of heat loss in a home, so it is essential to choose windows that will help keep the heat inside. There are many different types of energy-efficient windows on the market, so you can find ones that fit your style and budget.

### 3. Green Roof

Green roofs have become more popular because they help insulate a home and reduce the amount of heat lost through the roof. They also help reduce stormwater runoff and provide additional living space for plants and animals.

### 4. Solar Power

Solar power is a renewable energy source that heats and cools a home and provides electricity. Solar power is becoming increasingly affordable, and it is a great way to reduce your carbon footprint.



## 5. Water Conservation

Several ways to help conserve water in your home include installing reduced showerheads and toilets, collecting rainwater in barrels, and xeriscaping your landscaping. Water conservation is important because it helps reduce the amount of water in a home, saving money on your water bill.

## 6. Recycling

Recycling is an excellent way to minimize the amount of waste generated in the home. It is also a great way to reuse materials. There are many different recycling programs, so you can find one that works for your family.

## 7. Landscaping

Landscaping can help reduce the amount of heat absorbed by a home, and it can also allow cooling of the air around a house. Trees and shrubs can provide shade and windbreaks, and they can also help filter pollutants.

### Advantages

- Cost-effective.
- Improved Health
- Increased Efficiency
- Better Environment
- Higher Market Value



## Environment and Sustainability

- Water Conservation
- Psychologically-optimized Environment

### **Disadvantages**

- Location:
- Availability:
- No air cooling features:
- A long time to construct:
- The cost of construction

### **5.9 Green materials**

The concept of sustainable building incorporates and integrates a variety of strategies during the design, construction and operation of building projects. The use of green building materials and products represents one important strategy in the design of a building.

#### **Criteria**

- i. Local availability of materials
- ii. Embodied energy of materials
- iii. % of recycled/waste materials used
- iv. Rapidly renewable materials
- v. Contribution in Energy Efficiency of buildings
- vi. Recyclability of materials
- vii. Durability
- viii. Environmental Impact



## Environment and Sustainability

### **Benefits**

- Reduced maintenance/replacement costs over the life of the building.
- Energy conservation.
- Improved occupant health and productivity.
- Lower costs associated with changing space configurations.
- Greater design flexibility.

### **Resources**

- [Green Building Home](#)
- [Green Building Tool Kit](#)
- [Construction & Demolition Recycling](#)
- [Contracts & Grants](#)
- [Project Design Elements](#)
- [Programs & Partnerships](#)
- [Residential](#)
- [Schools](#)
- [Case Studies](#)
- [Links](#)

### **Overall material/product selection criteria:**

- Resource efficiency
- Indoor air quality
- Energy efficiency
- Water conservation
- Affordability



## Green building materials

Green building is construction that primarily uses natural materials and renewable resources. These structures look really cool but also feature design benefits such as thermal efficiency and safety features.

❖ Stone	❖ Earth-packed tires
❖ Cob	❖ Upcycled plastic
❖ Bamboo	❖ Shipping container scraps
❖ Cork	❖ Steel rods
❖ Adobe brick	❖ Newspaper wood
❖ Straw bale	❖ Recycled glass
❖ Cordwood	❖ Mycelium
❖ Earth bags	

### 5.10 Energy Efficiency

Energy efficiency is measured as the ratio of energy output to energy input, as a percentage. The goal of improving energy efficiency is to deliver the same service to the end user, using less energy.<sup>1</sup>

Energy efficiency is assessed at different levels, from individual appliances and buildings, to economy-wide and regional energy use. The energy efficiency of a motor would consider how much energy is produced for a given input; similarly, the energy efficiency of a supply chain would assess various inputs (i.e. the energy required to produce, ship, and manufacture component parts) in comparison to the output (the energy efficiency of the manufacturing process itself).<sup>1</sup>



## Environment and Sustainability

Energy efficiency is a key solution for countries to achieve their emission targets and is a site of continual improvement. **However, global progress on improving energy efficiency is slowing down.** One important indicator of trends in global energy use is improvements in *primary energy intensity*, which improved by just 1.2% in 2019. This slowdown in energy efficiency is attributed to rising demand for primary energy fuels from energy-intensive industries, changing weather patterns (i.e. colder winters, warmer summers, and other temperature anomalies), and structural changes (e.g. transportation modes, building floor area per person) and ineffective energy efficiency policy).

### Methods of achieving energy efficiency

- ❖ Energy Management Team
- ❖ Savers electricity consumption (Enerateq)
- ❖ Control and Manage Machinery Use
- ❖ Using LED and Solar lighting
- ❖ Optimizing Air Compressors

### Formula for calculating energy efficiency

Calculate the percentage of the input energy ending up in the desired output and you have the efficiency:

$$\text{Efficiency} = \frac{\text{energy out}}{\text{energy in}} \times 100 \%$$

### Advantages

- These types of energy sources are environmentally friendly. They do not release toxic gases like carbon dioxide.



#### Environment and Sustainability

- These energy sources do not run out and replenish naturally.
- They are safer for our health as they don't generate toxic residues harmful to people.
- They also freely exist in nature.

#### **DISADVANTAGES**

- ❖ The Electricity Generation Capacity is Still Not Large Enough.
- ❖ Renewable Energy Can be Unreliable.
- ❖ Low-efficiency Levels.
- ❖ Requires a Huge Upfront Capital Outlay.
- ❖ Takes a Lot of Space to Install.
- ❖ Expensive Storage Costs.
- ❖ Not Always a Commercially-viable Option.
- ❖ It Still Generates Pollution.

#### **5.11 Sustainable transport**

Sustainable transportation refers to low- and zero-emission, energy-efficient, affordable modes of transport, including electric and alternative-fuel vehicles, as well as domestic fuels.

#### **Benefits of sustainable transportation**

- Cost savings on fuel and vehicles
- Reduced carbon emissions from burning fossil fuels, resulting in less air pollution



### Environment and Sustainability

- Job creation with increased vehicle and battery manufacturing and fuel production
- Improved accessibility to reliable, affordable transportation options for all Americans
- Enhanced energy security and independence with less reliance on foreign sources of materials and fuels.

### Advantages

- Less Pollution and Clearer Skies
- Healthier Communities
- Harmful Chemicals Are Reduced
- Fewer Cars Equal Fewer Roads
- Noise Is Also Pollution

### Disadvantages

- ❖ The initial purchase of reusable containers.
- ❖ Modifications to handling and transport facilities.
- ❖ Additional costs of the tracking system, eg software packages, bar code labelling/reading equipment, electronic chips and detectors.

### 5.12 Sustainable energy

It is derived from resources that can maintain current operations without jeopardizing the energy needs or climate of future generations. The most popular sources of sustainable energy, including wind, solar and hydropower, are also renewable.

Examples of renewable energy sources include **wind power, solar power, bioenergy and hydroelectric, including tidal energy.**

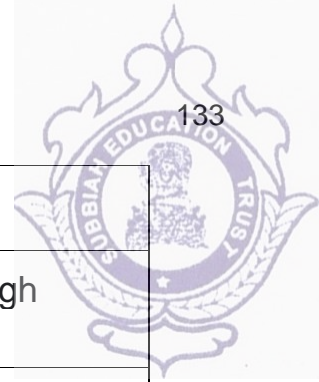

## Environment and Sustainability

Advantages	Disadvantages
Renewable energy won't run out	Renewable energy has high upfront costs
Renewable energy has lower maintenance requirements	Renewable energy is intermittent
Renewables save money	Renewables have limited storage capabilities

**5.13 Non-conventional sources**

1. Solar energy
2. Wind energy
3. Hydro energy
4. Tidal energy
5. Geothermal energy
6. Biomass energy

**1. Solar energy**

The energy we get directly from the sun is called solar energy.

The nuclear fusion reactions occurring inside the sun release enormous amount of energy in the form of heat and light.

**Methods of harvesting solar energy****a. Solar cell or photovoltaic cell or PV cells**

- Solar cells are devices that convert **solar energy into electrical energy.**
- Solar cells make use of **photovoltaic effect** and so they are called photovoltaic cells or simply PV cells.
- A solar cell consists of a **p-type semiconductor** (such as **Si doped with B**) and **n-type semiconductor** (such as **Si doped**



Environment and Sustainability

**with P**). They are close in contact with each other. When the solar rays fall on the top layer of p-type semiconductor, the electrons from the valence band get promoted to the conduction band and cross the p-n junction into n-type semiconductor.

- Thereby potential difference between two layers is created which causes flow of electrons.

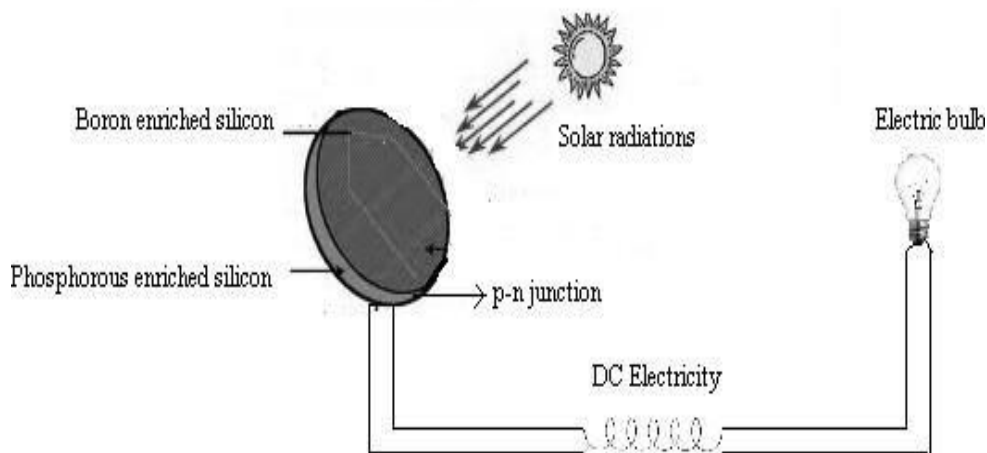

Advantages	Disadvantages
<ul style="list-style-type: none"> <li>• Solar cells are used in calculators, electronic watches, street lights, waterpumps to run radio &amp; TV.</li> </ul>	<ul style="list-style-type: none"> <li>• Capital cost is higher.</li> </ul>
<ul style="list-style-type: none"> <li>• It can be used in remote and isolated areas, forests and hilly regions.</li> </ul>	<ul style="list-style-type: none"> <li>• Storage of solar energy is not possible.</li> </ul>
<ul style="list-style-type: none"> <li>• Maintenance cost is low.</li> </ul>	<ul style="list-style-type: none"> <li>• It produces only DC voltage.</li> </ul>
<ul style="list-style-type: none"> <li>• Their life time is long.</li> </ul>	<ul style="list-style-type: none"> <li>• Solar energy is not available throughout day and night.</li> </ul>

**b. Solar battery**

When a large number of solar cells are connected in series, it forms a solar battery which is used to run water pump, to run street

Environment and Sustainability  
lights etc.

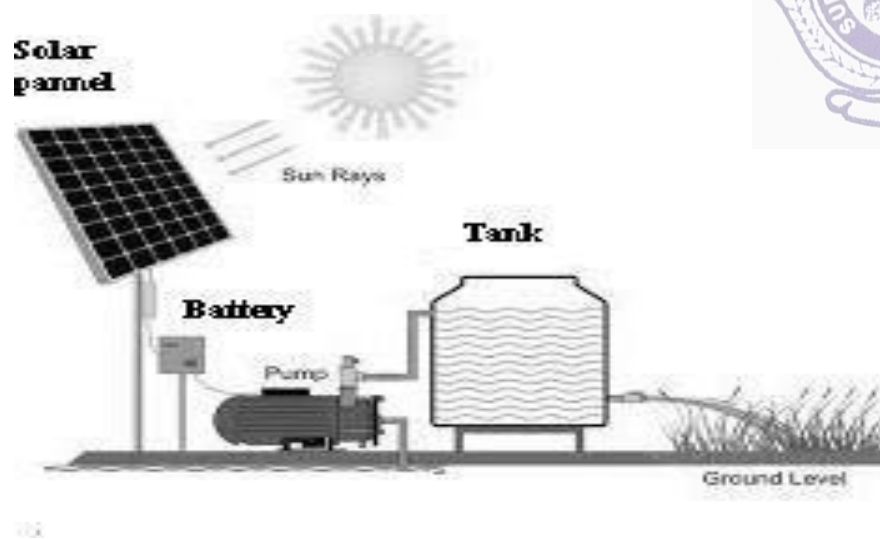

### c. Solar heat collector

- Materials like stones, bricks; glass etc can absorb heat during the day time and release it slowly at night.
- It is used in cold places where houses are kept in hot condition.

### d. Solar water heater

- It consists of an insulated box inside of which is painted with black paint.
- It is also provided with a glass lid to receive and store solar heat.
- Inside the box, it has black painted copper coil through which cold water is allowed to flow in, which gets heat up and flows out into a storage tank.
- From the storage tank, water is then supplied through pipes.

## 2. Wind energy

- Energy recovered from the force of the wind is called wind energy.
- This wind energy can also be converted into **mechanical and electrical energies**.



Environment and Sustainability

- The wind energy is produced by making use of wind mills.

**Methods of harvesting wind energy**

**a. Wind mills**

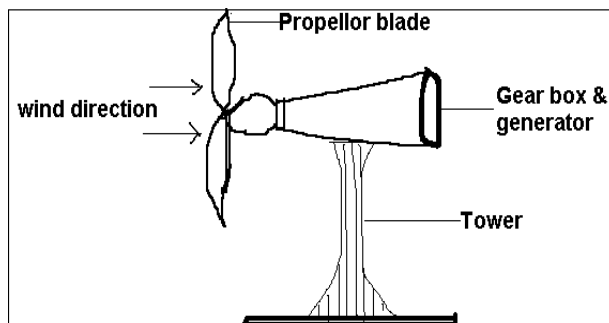

- It consists of wheel containing number of blades.
- The strikes of blowing wind make it rotating continuously and electric current is produced.
- (i.e.) the kinetic energy of the wind is converted into electric energy.

Advantages	Disadvantages
• It does not cause any air pollution.	• It produces unwanted sound.
• It is very cheap and economic.	• It affects the migratory routes of birds.
• It is renewable.	• Wind turbines interfere with electromagnetic signals.
• It is used to operate water pump, flour mills and electric generators.	

**b. Wind farms:**

When a large number of mills are installed and joined together in a definite pattern – it forms wind farm. It produces large amount of electricity.



Environment and Sustainability

Condition is minimum speed for wind generator is 15 Km/hr

### Advantages:

1. It does not cause air pollution

2. Very cheap

### 3. Ocean energy

Tidal energy (or) Tidal power	Ocean thermal energy
<ul style="list-style-type: none"> <li>Ocean tides produced by gravitational forces of sun and moon, produces large amount of energy.</li> </ul>	<ul style="list-style-type: none"> <li>There is large temperature difference between the surface level and deeper level of the tropical oceans.</li> </ul>
<ul style="list-style-type: none"> <li>The 'High tide' and 'Low tide' refer to the rise and fall of water in the oceans.</li> </ul>	<ul style="list-style-type: none"> <li>The energy due to difference in temperature of water is called ocean thermal energy.</li> </ul>

### 4. Geothermal energy

- The internal heat of earth used for power generation is called geothermal energy.
- The volcanic regions are suitable place to harness this geothermal energy.
- The hot springs and geysers of hot water can be used for this purpose.

### 5. Bio-mass energy

- Bio-mass is the organic matter produced by plants or animals, used as source of energy.
- E.g.) wood, crop residues, cattle dung



Environment and Sustainability

**Bio mass:** Organic matter produced by plants or animals used as source of energy

#### 5.14 Energy cycle:

1. The biogeochemical cycle which utilizes or releases energy through various biochemical processes such as respiration and photosynthesis is termed an energy cycle.
2. The Sun is the main source of energy for all the processes or activities taking place on Earth. The energy obtained from the sun is called solar energy which ensures whatever the energy is taken by us (living organisms) from the earth and its atmosphere is returned to it back through some way.
3. For example, the body of human beings is composed of carbon, nitrogen, and oxygen compounds which are returned to the atmosphere in their elemental form.
4. Human beings return oxygen in the form of carbon dioxide by respiration and water is returned in the form of urine or sweat to the atmosphere.

#### 5.15 Carbon Cycle

Carbon cycle is the process where carbon compounds are interchanged among the biosphere, geosphere, pedosphere, hydrosphere, and atmosphere of the earth.

##### Carbon Cycle Steps

Following are the major steps involved in the process of the carbon cycle:



## Environment and Sustainability

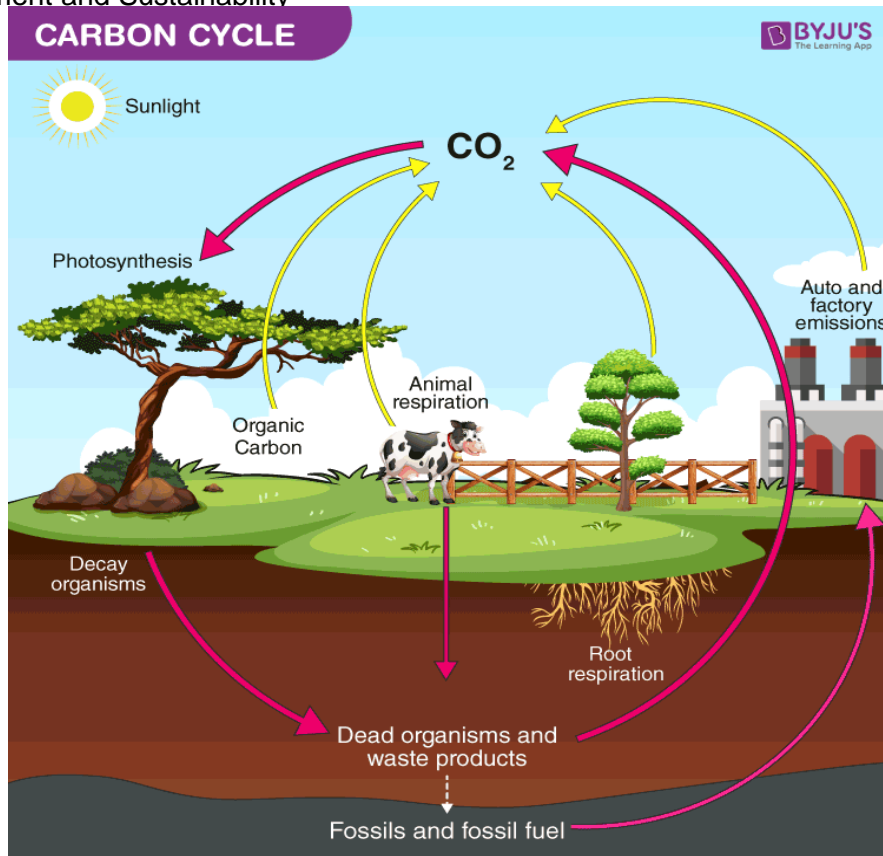

1. Carbon present in the atmosphere is absorbed by plants for photosynthesis.
2. These plants are then consumed by animals and carbon gets bioaccumulated into their bodies.
3. These animals and plants eventually die, and upon decomposing, carbon is released back into the atmosphere.
4. Some of the carbon that is not released back into the atmosphere eventually become fossil fuels.
5. These fossil fuels are then used for man-made activities, which pump more carbon back into the atmosphere.

Carbon Cycle diagram showing the flow of carbon, its sources and paths.



Environment and Sustainability  
**Carbon Cycle on Land**

Carbon in the atmosphere is present in the form of carbon dioxide. Carbon enters the atmosphere through natural processes such as respiration and industrial applications such as burning fossil fuels. The process of photosynthesis involves the absorption of CO<sub>2</sub> by plants to produce carbohydrates. The equation is as follows:

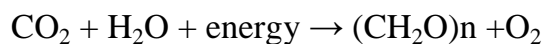

Carbon compounds are passed along the food chain from the producers to consumers. The majority of the carbon exists in the body in the form of carbon dioxide through respiration. The role of decomposers is to eat the dead organism and return the carbon from their body back into the atmosphere. The equation for this process is:

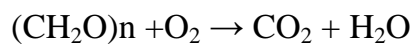

### **Importance of Carbon Cycle**

Even though carbon dioxide is found in small traces in the atmosphere, it plays a vital role in balancing the energy and traps the long-wave radiations from the sun. Therefore, it acts like a blanket over the planet. If the carbon cycle is disturbed it will result in serious consequences such as climatic changes and global warming.

Carbon is an integral component of every life form on earth. From proteins and lipids to even our DNA. Furthermore, all known life on earth is



Environment and Sustainability

based on carbon. Hence, the carbon cycle, along with the nitrogen cycle and oxygen cycle, plays a vital role in the existence of life on earth.

### 5.16 Sequestered emissions

Geological carbon sequestration **happens when carbon is stored in places such as underground geological formations or rocks.** This process is largely artificial or 'direct', representing an effective way of neutralising emissions put into human practices, such as manufacturing or construction.

#### **What is carbon sequestration?**

Carbon dioxide is the most commonly produced greenhouse gas. Carbon sequestration is the process of capturing and storing atmospheric carbon dioxide. It is one method of reducing the amount of carbon dioxide in the atmosphere with the goal of reducing global climate change. The USGS is conducting assessments on two major types of carbon sequestration: geologic and biologic.

#### **Purpose**

Carbon sequestration is the process of capturing, securing and storing carbon dioxide from the atmosphere. The idea is to stabilize carbon in solid and dissolved forms so that it doesn't cause the atmosphere to warm.

#### **Advantages**

One major concern with CCS is that **CO<sub>2</sub> could leak out of these underground reservoirs into the surrounding air and contribute to climate change, or taint nearby water supplies.** Another is the risk of human-made tremors caused by the build-up of pressure underground, known as induced seismicity.



## Impacts of Carbon Sequestration

- About 25 percent of our carbon emissions have historically been captured by **Earth's forests, farms and grasslands**. Scientists and land managers are working to keep landscapes vegetated and soil hydrated for plants to grow and sequester carbon.
- As much as 30 percent of the carbon dioxide we emit from burning fossil fuels is absorbed by the upper layer of the ocean. But this raises the water's acidity, and **ocean acidification** makes it harder for marine animals to build their shells. Scientists and the fishing industry are taking proactive steps to monitor the changes from carbon sequestration and adapt fishing practices.

### 5.17 Green engineering

Green engineering is the design, commercialization, and use of processes and products in a way that reduces pollution, promotes sustainability, and minimizes risk to human health and the environment without sacrificing economic viability and efficiency.

Green engineering embraces the concept that decisions to protect human health and the environment can have the greatest impact and cost-effectiveness when applied early, in the design and development phase of a process or product.

#### Principles of Green Engineering

Green engineering processes and products:

- Holistically use systems analysis and integrate environmental impact assessment tools.



### Environment and Sustainability

- Conserve and improve natural ecosystems while protecting human health and well-being.
- Use life-cycle thinking in all engineering activities.
- Ensure that all material and energy inputs and outputs are as inherently safe and benign as possible.
- Minimize depletion of natural resources.
- Strive to prevent waste.

Additionally, green engineering:

- Develops and applies engineering solutions while being cognizant of local geography, aspirations, and cultures.
- Creates engineering solutions beyond current or dominant technologies; improves, innovates, and invents (technologies) to achieve sustainability.
- Actively engages communities and stakeholders in the development of engineering solutions.

### Benefits

- Enhances business Practices
- Improves companies reputation
- Minimise energy
- Provides tax incentives
- Help the global environment

Here are a few examples of green engineering strategies in a workplace:

- Biodegradable cups and straws
- Enhance industrial emission filters



## Environment and Sustainability

- Waste water treatment
- Radiant flows
- Plant based cooling

### 5.18 Sustainable urbanisation

**Sustainable urbanism** is both the study of cities and the practices to build them (urbanism), that focuses on promoting their long term viability by reducing consumption, waste and harmful impacts on people and place while enhancing the overall well-being of both people and place. Well-being includes the physical, ecological, economic, social, health and equity factors, among others, that comprise cities and their populations. In the context of contemporary urbanism, the term **cities** refers to several scales of human settlements from towns to cities, metropolises and mega-city regions that includes their peripheries / suburbs / exurbs.

Sustainability is a key component to professional practice in urban planning and urban design along with its related disciplines landscape architecture, architecture, and civil and environmental engineering. Green urbanism and ecological urbanism are other common terms that are similar to sustainable urbanism, however they can be construed as focusing more on the natural environment and ecosystems and less on economic and social aspects. Also related to sustainable urbanism are the practices of land development called Sustainable development, which is the process of physically constructing sustainable buildings, as well as the practices of urban planning called smart growth or growth management, which denote the processes of planning, designing, and building urban settlements that are more



Environment and Sustainability  
sustainable than if they were not planned according to sustainability criteria  
and principles.

### **Elements**

- Energy efficiency/clean energy resources
- Improved indoor environment
- Source reduction, pollution prevention and recycling
- Component optimization
- Multifunctional optimization
- Integrated design

### **Advantages of urbanization:**

- The problem of unemployment will be solved
- High transportation facilities
- More education opportunities
- Recycling process
- Internet connections will be available
- More modernized equipment
- Higher wages in cities on average

### **Disadvantages of Urbanization:**

- Chances of the higher levels of pollutions like air, noise etc.
- Higher level of stress
- Lack of natural spaces
- There will be chances of spreading diseases.
- Traffic issues will be more.



### 5.19 Socio economical change on sustainable urbanisation

Urbanisation has many adverse effects in the structure of society because,

- ❖ Population increase causes housing problems.
- ❖ Overcrowding.
- ❖ Unemployment.
- ❖ Development of Slums.
- ❖ Water and Sanitation Problems.
- ❖ Poor Health and Spread of Diseases.
- ❖ Traffic Congestion.
- ❖ Urban Crime.

### Technological change of sustainable urbanization

Technological changes involves the introduction of something new or a new idea method or device. Technological innovations, as part of technological change allows organisations to test new ideas as speeds and prices that were newer anticipated ago

- ❖ Technological innovation has changed the overall effectiveness and benevedence over time and with regard to sustainability
- ❖ Upgrading of industrial structure improve the sustainable urbanization.
- ❖ Technological change and sustainability are closely related to each other.
- ❖ Both factors from the innovation in order to improve the effectiveness of environmental and social development and economic progress
- ❖ The combination of digital technology in the business model will established and empower city to be more sustainable.



Environment and Sustainability  
**5.20 Part A**

**1. What are zero waste. Give example**

Zero waste is a set of principles focused on waste prevention that encourages redesigning resource life

**2. Define circular economy**

A circular economy strives for the longest possible use of products and raw materials. In practical terms, this means avoiding waste through reuse or further use (recycling / reuse). If that is not possible, they are broken down into their starting materials, i.e. raw materials, and these are recycled. Waste avoidance and reuse always come before recycling.

**3. What are ISO 14000 series**

ISO 14000 is defined as a series of international environmental management standards, guides, and technical reports.

**4. Define life cycle assessment**

A Life Cycle Assessment (LCA) is an analysis of the impact one object has on the world around it. In this guide, you get an in-depth, non-technical overview of:

- What a Life Cycle Assessment really is,
- The different approaches to it,
- How it works in practice,
- And who can benefit from it.

**5. What are sustainable habitat**

A sustainable habitat is achieving stability between the economic and social development of human habitats together with the defense of



Environment and Sustainability

the environment, shelter, basic services, social infrastructure, and transportation.

## 6. Define green building

A green or sustainable building is a building that, because of its construction and features, can maintain or improve the quality of life of the environment in which it is located.

## 7. What are the advantages and disadvantages of green building

Advantages	Disadvantages
● Cost-effective.	● Location:
● Improved Health	● Availability:
● Increased Efficiency	● No air cooling features:

## 8. What are green materials. Give example

It is derived from resources that can maintain current operations without jeopardizing the energy needs or climate of future generations. The most popular sources of sustainable energy, including wind, solar and hydropower, are also renewable.

## 9. Define sustainable transport give example

Sustainable transportation refers to low- and zero-emission, energy-efficient, affordable modes of transport, including electric and alternative-fuel vehicles, as well as domestic fuels.

## 10. Define sustainable energy

It is derived from resources that can maintain current operations without jeopardizing the energy needs or climate of future generations. The



## Environment and Sustainability

most popular sources of sustainable energy, including wind, solar and hydropower, are also renewable.

### **11. Define emission and sequestration**

Geological carbon sequestration **happens when carbon is stored in places such as underground geological formations or rocks.** This process is largely artificial or 'direct', representing an effective way of neutralising emissions put into human practices, such as manufacturing or construction.

Carbon dioxide is the most commonly produced greenhouse gas. Carbon sequestration is the process of capturing and storing atmospheric carbon dioxide. It is one method of reducing the amount of carbon dioxide in the atmosphere with the goal of reducing global climate change.



Environment and Sustainability  
**5.21 Part B & C**

1. Explain zero waste and r concept
2. Write a short note on circular economy
3. Explain ISO 14000 series
4. Explain in detail material life cycle assessment
5. Write a short note on EIA
6. Explain sustainable habitat with its characteristics and objective.
7. Explain sustainable transport
8. What is solar cell give its construction with advantages and disadvantages
9. Explain carbon cycle with the diagram
10. Explain the principle and benefits of green engineering
11. What is sustainable urbanisation. Explain with the advantages and disadvantages



Environment and Sustainability

**ANNA UNIVERSITY MODEL QUESTION PAPER  
GE3451/ENVIRONMENT AND SUSTAINABILITY**

**Time: 3 hours  
Marks: 100**

**PART – A (10×2=20)**

1. What is energy flow of a n ecosystem
2. Define biodiversity
3. Define water system
4. What are E wastes. Give Eg.
2. Define energy conservation
3. What is the origin of geothermal plant
4. What is GDP
5. Define carbon credit
6. What are zero wastes. Give eg.
7. Define green building.

**PART – B (5×13=65)**

8. a) Explain ecological succession  
(or)  
b) Explain the conservation of biodiversity
9. a) Explain the sources, effects and control measures of air pollution  
(or)  
b) Explain solid waste management
10. a) Explain new energy sources  
(or)  
b) Explain the type of geothermal plant with diagram
11. a) Explain the need approaches and aspects of sustainability  
(or)  
b) Write a short note on climate change
12. a) Explain ISO 14000 series  
(or)  
b) Explain carbon cycle with the diagram

**PART – C (1×15=15)**

- 16 a) What is sustainable urbanisation. Explain with the advantages and disadvantages  
(or)  
b) Explain sustainable development with goal targets and indicators